



PROGRAMMING MANUAL

CLONING SOFTWARE

CS-F3

FOREWORD

This manual explains in detail how to program each of the functions in the IC-F3/S and IC-F4/S VHF AND UHF TRANSCEIVERS with the CS-F3 CLONING SOFTWARE. The CS-F3 can be set up to meet any number of requirements of your customers such as system conditions, channels, frequencies, tones, etc.

IMPORTANT

Before using the program, make a backup copy of the original disk. Operate the program using the backup and keep the original in a safe place.

TABLE OF CONTENTS

FOREWORD	i	7 SETUP MENU OPERATION	45
IMPORTANT	i	7-1 DISPLAY TYPE	45
TABLE OF CONTENTS	i	7-3 RS-232C	45
1 PREPARATION	1	8 PROGRAMMING for SmarTrunk II operation	46-48
2 SCREEN DESCRIPTION	2-3	8-1 STARTING THE PROGRAM	46
File menu	2	8-2 Speed Dial	47
Screen menu	2-3	8-3 Configuration	48
Clone menu	3	9 PROGRAMMING for TRUNKING operation	49-51
Print menu	3	9-1 STARTING THE PROGRAM	49
Model menu	3	9-2 Global	50
Setup menu	3	9-3 System 1, System 2	51
3 FILE MENU OPERATION	4	10 CLONING	52
3-1 LOAD	4	11 INDEX	53
3-2 SAVE	4		
3-3 DELETE	4		
4 SCREEN MENU OPERATION— LMR . . .	5-20		
4-1 MEMORY CH	5-8		
4-2 KEY & DISPLAY ASSIGN	9-12		
4-3 DTMF AUTODIAL	13		
4-4 CONTINUOUS TONE	13		
4-5 SCAN FUNCTION	14		
4-6 2TONE CODE CH	15-16		
4-7 COMMON	17-19		
4-8 EXPERT	20		
5 SCREEN MENU OPERATION—PMR . . .	21-43		
5-1 MEMORY CH	21-27		
5-2 KEY & DISPLAY ASSIGN	28-31		
5-3 DTMF AUTODIAL	32		
5-4 CONTINUOUS TONE	32		
5-5 SCAN FUNCTION	33		
5-6 RX CODE CH	34-36		
5-7 TX CODE CH	37-38		
5-8 5TONE FORMAT	39		
5-9 COMMON	40-42		
5-10 EXPERT	43		
6 CLONE MENU OPERATION	44		
6-1 READ ← TR	44		
6-2 WRITE → TR	44		
6-3 INFORMATION	44		

■ EQUIPMENT REQUIRED

- To use the program, the following hardware and software is required:
- IBM PC/AT or PS/2 compatible computer with an RS-232C serial port
 - MS-DOS, PC-DOS or IBM DOS ver. 5.02 or higher
 - OPC-478 CLONING CABLE
 - Printer (to printout cloning data)

■ CONNECTION

Connect each item as in the following diagram.

CAUTION: Do not connect an antenna to the transceiver during cloning operation. Received signals may cause cloning errors.

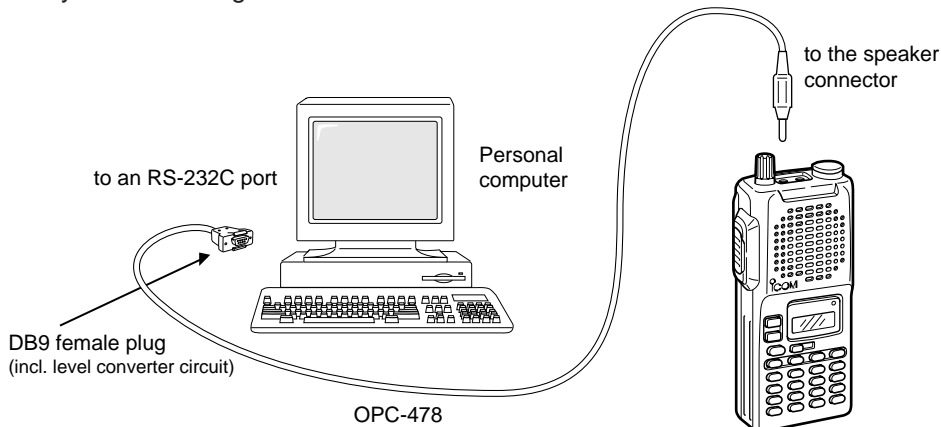

■ STARTING THE PROGRAM

- ① Boot up DOS.
- ② Insert the CS-F3 backup disk into drive A*.
- ③ Type the following to start the program
iccf3.exe [Enter], or csf3.exe [Enter]
When csf3.exe is typed to start the program, skip step ④.
- ④ Select "IC-F3/F4 series" with the arrow keys ([↑] and [↓]), then push [Enter] key to start the program.
- ⑤ After the start up screen appears, set or modify the data as desired.
 - By pushing [Alt] or [Esc] key, the TOP menu will be brought up.
 - Use the arrow keys ([↑], [↓], [←] and [→]) to select menu then push [Ent] or push *highlighted character keys* to open the desired menu.
 - The [Space] key or *Digit keys* toggle the setting.
- ⑥ Use the "File" menu to save the data and to exit the program.

All cloning operations are performed from the computer's keyboard (not from a mouse)—the only operation required on the transceiver side is power on.

*According to the PC's condition.

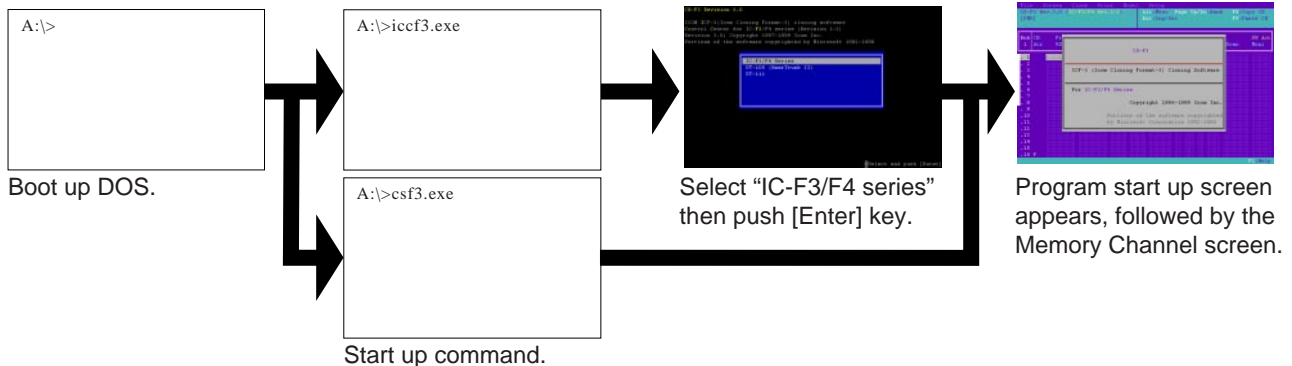

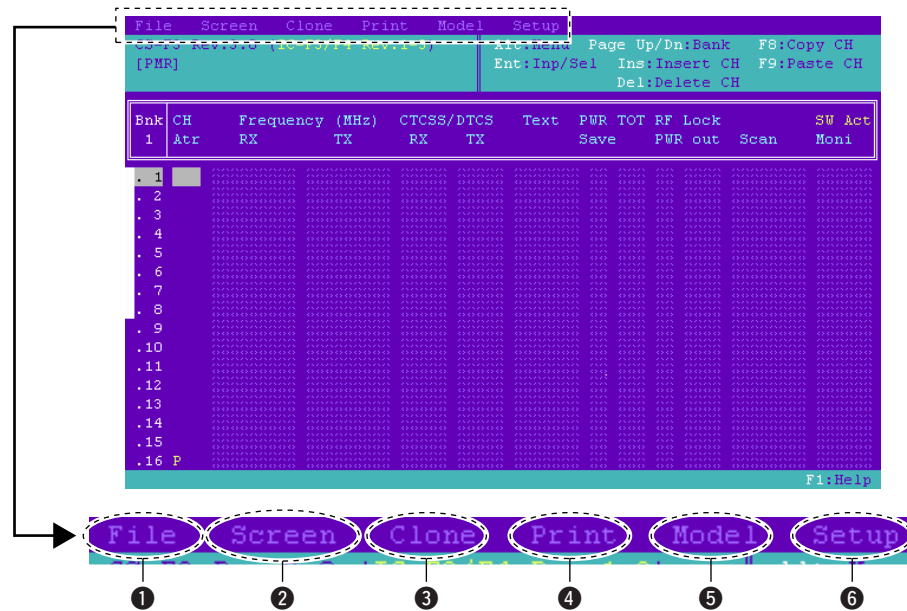

1 File menu

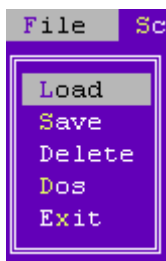

- ① Load (p. 4)
Loads saved programming data from the specified disk/folder (directly). File table capability is available.
- ② Save (p. 4)
Saves programming data to a desired disk/file. File extension, [.ICF], is added automatically. File table capability is available.
- ③ Delete (p. 4)
Deletes a specified file. File table capability is available.
- ④ Dos
Allows you to use a DOS command. To return to the previous screen, type "EXIT" then press [Enter].
- ⑤ Exit
Quits and exits the program, then returns to the DOS prompt.

2 Screen menu

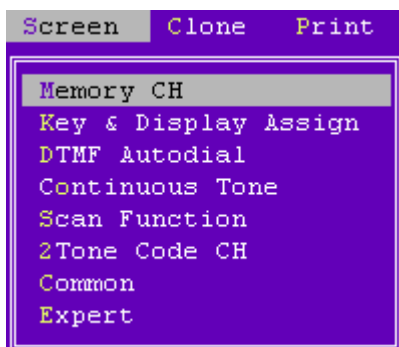

- For LMR—* appears only when LMR is selected in the Model menu. (p. 3)
- ⑥ Memory CH (pgs. 5–8)
Sets operating frequencies and details.
 - ⑦ Key & Display Assign (pgs. 9–12)
Sets programmable key assign and display conditions, etc.
 - ⑧ DTMF Autodial (p. 13)
Sets automatic DTMF transmission condition, etc., up to 5 DTMF codes can be programmed.
 - ⑨ Continuous Tone (p. 13)
Sets preset CTCSS frequencies or DTCS codes, up to 9 pairs (RX and TX) frequencies or codes can be programmed.
 - ⑩ Scan Function (p. 14)
Sets scanning mode, conditions, etc.
 - ⑪ 2Tone Code CH (pgs. 15–16)
Sets 2-tone operating conditions.
 - ⑫ Common (pgs. 17–19)
Sets commonly used timers, user password, etc.
 - ⑬ Expert (p. 20)
Sets extra customizable timers and features.

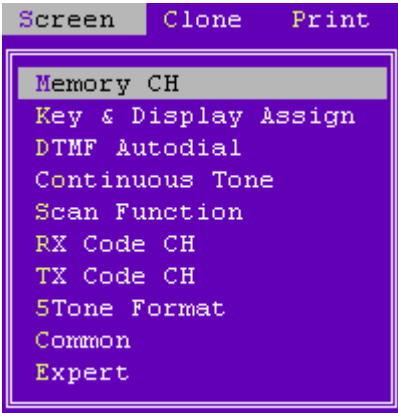

- For PMR**— appears only when PMR is selected in the Model menu as follow.
- ⑭ **Memory CH** (pgs. 21–27)
Sets operating frequencies and details.
 - ⑮ **Key & Display Assign** (pgs. 28–31)
Sets programmable key assign and display conditions, etc.
 - ⑯ **DTMF Autodial** (p. 32)
Sets automatic DTMF transmission condition, etc., up to 5 DTMF codes can be programmed.
 - ⑰ **Continuous Tone** (p. 32)
Sets preset CTCSS frequencies or DTCS codes, up to 9 pairs (RX and TX) frequencies or codes can be programmed.
 - ⑱ **Scan Function** (p. 33)
Sets scanning mode, conditions, etc.
 - ⑲ **RX Code CH** (pgs. 34–36)
Sets receive 5-tone code, action, etc.
 - ⑳ **TX Code CH** (pgs. 37–38)
Sets transmit 5-tone code, conditions, etc
 - ㉑ **5Tone Format** (p. 39)
Specifies using 5-tone system.
 - ㉒ **Common** (pgs. 40–42)
Sets commonly used timers, user password, etc.
 - ㉓ **Expert** (pgs. 43)
Sets extra customizable timers and features.

③ Clone menu

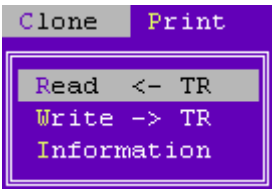

- ⑳ **Read <- TR** (p. 44)
Reads the programmed data from the connected transceiver.
- ㉑ **Write -> TR** (p. 44)
Programs setup data to the connected transceiver.
- ㉒ **Information** (p. 44)
Shows detailed information of the connected transceiver.

④ Print menu

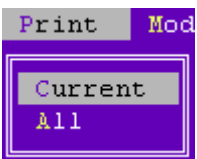

- ㉓ **Current**
Prints out currently displayed screen data.
- ㉔ **All**
Prints out all set data.

⑤ Model menu



- ㉕ **LMR**
Only the LMR functions (2-tone) can be selected.
- ㉖ **PMR**
Only the PMR functions (5-tone) can be selected.

⑥ Setup menu

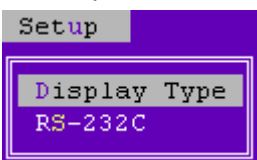

- ㉗ **Display Type** (p. 45)
Selects the display type from color, monochrome 1 and 2.
- ㉘ **RS-232C** (p. 45)
Selects one of the computer's RS-232C ports for cloning connection.

3

FILE MENU OPERATION

3-1 LOAD

```
File Name (Load)
A:\sample1.ICF

File Name (Load)
A:\*.ICF
1 ADJ <DIR>
2 SAMPLE1 .ICF Jun-08-99 9:10 #
3 SAMPLE2 .ICF Jun-08-99 9:10 #
4 SAMPLE3 .ICF Jun-08-99 9:10 #
5 SAMPLE4 .ICF Jun-08-99 9:11 #
6 SAMPLE5 .ICF Jun-08-99 9:11 #
7
8
9
10
11
12
13
14
15
16 P
```

Enter the file name then push [Ent] when exact file name is known to load stored programming data.

When exact file name is unknown, enter wildcard (*) then push [Ent] to display the file table. Select a file with [↑]/[↓] key from the file table then push [Ent] to load stored programming data.

The clone comment programmed in **Clone Comment** in *4-7/5-9 Common* (p. 17: LMR/p. 40: PMR) is shown in the file table for simple file selection and management by the using file name as well as a clone comment combination.

Go to Clone Comment— LMR

Go to Clone Comment— PMR

3-2 SAVE

```
File Name (Save)
A:\sample6.ICF

File Name (Save)
A:\*.ICF
1 ADJ <DIR>
2 SAMPLE1 .ICF Jun-08-99 9:10 #
3 SAMPLE2 .ICF Jun-08-99 9:10 #
4 SAMPLE3 .ICF Jun-08-99 9:10 #
5 SAMPLE4 .ICF Jun-08-99 9:11 #
6 SAMPLE5 .ICF Jun-08-99 9:11 #
7
8
9
10
11
12
13
14
15
```

Enter the file name then push [Ent], when saving the programming data with a specified file name.

Enter wildcard (*) then push [Ent] to display the file table, when confirming all available file names.

3-3 DELETE

```
File Name (Delete)
A:\*.ICF
1 ADJ <DIR>
2 SAMPLE1 .ICF Jun-08-99 9:10 #
3 SAMPLE2 .ICF Jun-08-99 9:10 #
4 SAMPLE3 .ICF Jun-08-99 9:10 #
5 SAMPLE4 .ICF Jun-08-99 9:11 #
6 SAMPLE5 .ICF Jun-08-99 9:11 #
7
8
9
10
11
12
13
14
15
16 P
```

Select the file with [↑]/[↓] key from the file table then push [Ent], when unnecessary files exist.

4-1 MEMORY CH

Bnk	CH	Frequency (MHz)		CTCSS/DTCS		Text	PWR Save	TOT	RF PWR	Lock out	Auto Scan	Reset
		RX	TX	RX	TX							
1	Atr											
. 1												
. 2												
. 3												
. 4												
. 5												
. 6												
. 7												
. 8												
. 9												
. 10												
. 11												
. 12												
. 13												
. 14												
. 15												
. 16	P											

• CH Atr

Selects the channel attribution from P (Priority), E (Emergency), and Emergency OFF.

Set the cursor to the CH Atr column, then push [Return] key to display the window as at right. Select the channel attribution by pushing [↑]/[↓] keys.



P: Priority— “P” tagged channel becomes a priority channel, simply recalled by pushing [Priority CH] switch and also is automatically monitored during the priority scan. Only 1 channel can be set.

E: Emergency— “E” tagged channel becomes an emergency channel, immediately recalled and sends emergency signal by pushing [Emergency Single] or [Emergency Repeat] switch. Only 1 channel can be set.

Emergency OFF— Regular channel.

SmarTrunk ON/OFF switches SmarTrunk II capabilities. In this case, an optional UT-105 SmarTrunk II Logic Board and extra programming with an EX-2095 application in the CS-F3 are required.

See pages 46–48, **8 PROGRAMMING for SmarTrunk II OPERATION**, for details.

[Priority CH], [Emergency Single] and [Emergency Repeat] switches are assigned in **4-2 KEY & DISPLAY ASSIGN** (pgs. 9, 11).

Go to 8 PROGRAMMING for SmarTrunk II OPERATION
Go to 4-2 KEY & DISPLAY ASSIGN

• Frequency— RX and TX

Enter receive and transmit frequencies within the following frequency range in either 5, 6.25 or 7.5 kHz steps* for the RX and TX columns, respectively.

IC-F3/S: 136–150, 146–174 MHz

IC-F4/S: 400–430, 440–470, 470–500, 490–512 MHz

*according to version

Transmit inhibit can be selected by pushing [Space] key.

When no receive frequency is entered, other data cannot be programmed in the channel.

When SmarTrunk ON/OFF is selected in **CH Atr** as at left, operating frequencies must be programmed from channel 1 without a blank.

• CTCSS/DTCS— RX and TX

Enter full CTCSS frequency (incl. decimal point; otherwise a DTCS code is entered) or a 3-digit DTCS code as well as polarity for receive and transmit in the RX and TX columns, respectively.

By pushing the [Enter] key, the CTCSS frequency list as at right appears for simple frequency selection. Also selectable with [Space] or [Back Space] keys without list indication.

DTCS	85.4	110.0	142.2	192.0	241.0
OFF	88.5	123.0	165.5	196.6	250.3
	87.0	91.5	127.3	167.9	199.5
	69.3	94.0	131.0	171.3	203.5
	71.0	97.4	135.5	173.0	206.5
	71.9	100.0	141.3	177.3	210.7
	74.4	103.5	146.2	179.9	210.1
	77.0	107.2	151.4	183.5	225.7
	79.7	110.9	156.7	186.2	229.1
	82.5	114.0	159.0	189.9	233.6

The polarity of DTCS is selectable by pushing the [Space] or [Back Space] key from N (Normal) and I (Inverse).

4 SCREEN MENU OPERATION— LMR

4-1 MEMORY CH— continued

Bnk	CH	Frequency (MHz)		CTCSS/DTCS		Text	PWR TOT	RF Lock	Auto
		RX	TX	RX	TX				
1	Atr								
. 1									
. 2									
. 3									
. 4									
. 5									
. 6									
. 7									
. 8									
. 9									
. 10									
. 11									
. 12									
. 13									
. 14									
. 15									
. 16	P								

• Text

Enter up to a 7-character text in the Text column for memory name, channel usage, etc.

The usable characters are A–Z, 0–9, \$, ', (,), -, /, <, =, >, @, [, \,], _, | and ~.

When no text is entered, the channel number is indicated.

• PWR Save

Selects power save capability from ON and OFF.

The power save start timings are programmed in the **PWR Save Start Timer (1st)/(2nd)** in **4-8 EXPERT** (p. 20).

When SmarTrunk ON/OFF is selected in **CH Atr** in this screen (p. 5), “OFF” must be selected.

Go to PWR Save Start Timer (1)/(2)

Go to CH Atr

• TOT

Selects time-out-timer function capability from ON and OFF.

Continuously transmittable time is limited by the timer when ON is selected. However, time-out timer must be set to ON due to local regulation, in some countries.

The time period is programmed in the **TOT— Timer** in **4-7 COMMON** (p. 17).

When SmarTrunk ON/OFF is selected in **CH Atr** in this screen (p. 5), “OFF” must be selected.

Go to TOT— Timer

Go to CH Atr

• RF PWR

Selects transmit output power from H (High) and L (Low).

The selected output power setting for each channel can be switched to either temporary or permanent, according to the setting in **RF PWR (H/L)** in **4-2 KEY & DISPLAY ASSIGN** (p. 11) via [High/Low] switch.

The [High/Low] switch is assigned in the **4-2 KEY & DISPLAY ASSIGN** (p. 10)

Go to RF PWR (H/L)

Go to 4-2 KEY & DISPLAY ASSIGN

• Lock out

Selects transmission lock out (temporary inhibit) capability from Busy, Rpt (Repeater) and OFF.

Busy : [PTT] switch cannot be activated while the operating channel/repeater is in use.

Rpt : [PTT] switch can be activated while receiving a signal with matched CTCSS (or DTCS) tone or no signals.

OFF : No restriction for receiving a signal.

In addition, [PTT] switch is not activated for an extra time period in the case of when the lockout penalty timer, programmed in the **Lockout Penalty Timer** in **4-7 COMMON** (p. 18), is activated even if the transceiver in a transmittable condition.

Go to Lockout Penalty Timer

4-1 MEMORY CH— continued

Bnk	CTCSS/DTCS	Text	PWR TOT	RF Lock	Auto	2Tone	Log	Scrambler
1	RX TX		Save	PWR out	Reset	Dec	IN/OFF	ON/OFF Code
. 1	*****	*****	*****	*****	*****	*****	*****	*****
. 2	*****	*****	*****	*****	*****	*****	*****	*****
. 3	*****	*****	*****	*****	*****	*****	*****	*****
. 4	*****	*****	*****	*****	*****	*****	*****	*****
. 5	*****	*****	*****	*****	*****	*****	*****	*****
. 6	*****	*****	*****	*****	*****	*****	*****	*****
. 7	*****	*****	*****	*****	*****	*****	*****	*****
. 8	*****	*****	*****	*****	*****	*****	*****	*****
. 9	*****	*****	*****	*****	*****	*****	*****	*****
. 10	*****	*****	*****	*****	*****	*****	*****	*****
. 11	*****	*****	*****	*****	*****	*****	*****	*****
. 12	*****	*****	*****	*****	*****	*****	*****	*****
. 13	*****	*****	*****	*****	*****	*****	*****	*****
. 14	*****	*****	*****	*****	*****	*****	*****	*****
. 15	*****	*****	*****	*****	*****	*****	*****	*****
. 16	*****	*****	*****	*****	*****	*****	*****	*****

• Scan

Selects scanning condition with permission of scanning list modification from “Blank” (Inh), “Blank” (Ena), Tag (Inh) and Tag (Ena).

The Tag (Inh) or Tag (Ena) selected channels are scanned.

“Blank” (Ena) or Tag (Ena) selected channels can be added or deleted to/from scan list by pushing and holding [Scan] switch.

When SmarTrunk ON/OFF is selected in **CH Atr** in this screen (p. 5), “Blank” (Inh) must be selected.

[Scan] switch is assigned in the **4-2 KEY & DISPLAY ASSIGN** (p. 9)

Go to CH Atr

Go to 4-2 KEY & DISPLAY ASSIGN

• Auto Reset

Selects reset timer from Tim-A and Tim-B to restarting scanning when the power ON scan function is turned ON.

Tim-A, Tim-B:

Restarts scanning after specified time (Timer A or Timer B) has passed from a disappearing signal or key operation is finished.

The time period of Timer A and Timer B are programmed in the **Auto Reset— Timer A, Timer B** in **4-7 COMMON** (p. 17), respectively.

To turn OFF the function, select the timer which OFF (0 sec.) is programmed.

The power ON scan function is specified in **PWR ON Scan** in **4-5 SCAN FUNCTION** (p. 14)

Go to Auto Reset— Timer A, Timer B

Go to PWR ON Scan

• 2Tone Dec

Selects transceiver's action when a matched 2-tone code is received from 1, 2, 3 and OFF.

1, 2, 3: Activates a specified channel 1, 2 or 3 as programmed in the **4-6 2TONE CODE CH** (pgs. 15, 16).

OFF : Nothing changes.

Go to 4-6 2TONE CODE CH

• Log IN/OFF

Selects automatic ID transmission condition in relation with [PTT] from L-IN, L-OFF, Both and OFF.

L-IN : ID is transmitted each time [PTT] is pushed.

L-OFF: ID is transmitted each time [PTT] is released.

Both : ID is transmitted each time [PTT] is pushed and released.

OFF : No ID is transmitted with [PTT].

Log/ID code is used as the ID code, programmed in **4-3 DTMF AUTODIAL** (p. 13).

When SmarTrunk ON/OFF is selected in **CH Atr** in this screen (p. 5), “OFF” must be selected.

Go to 4-3 DTMF AUTODIAL

Go to CH Atr

4 SCREEN MENU OPERATION—LMR

4-1 MEMORY CH— continued

Bnk	CTCSS/DTCSS	Text	PWR TOT	RF Lock	Auto	2Tone	Log	Scrambler
1	RX TX		Save	PWR out	Reset	Dec	IN/OFF	ON/OFF Code
. 1	*****	*****	*****	*****	*****	*****	*****	*****
. 2	*****	*****	*****	*****	*****	*****	*****	*****
. 3	*****	*****	*****	*****	*****	*****	*****	*****
. 4	*****	*****	*****	*****	*****	*****	*****	*****
. 5	*****	*****	*****	*****	*****	*****	*****	*****
. 6	*****	*****	*****	*****	*****	*****	*****	*****
. 7	*****	*****	*****	*****	*****	*****	*****	*****
. 8	*****	*****	*****	*****	*****	*****	*****	*****
. 9	*****	*****	*****	*****	*****	*****	*****	*****
. 10	*****	*****	*****	*****	*****	*****	*****	*****
. 11	*****	*****	*****	*****	*****	*****	*****	*****
. 12	*****	*****	*****	*****	*****	*****	*****	*****
. 13	*****	*****	*****	*****	*****	*****	*****	*****
. 14	*****	*****	*****	*****	*****	*****	*****	*****
. 15	*****	*****	*****	*****	*****	*****	*****	*****
. 16	*****	*****	*****	*****	*****	*****	*****	*****

• Scrambler— ON/OFF/INH

Selects voice scrambling function initial setting from ON, OFF and INH.

When ON or OFF is selected, the voice scrambling function can be manually switched with the [Scrambler] switch, however, the function cannot be manually switched ON when INH is selected.

An optional UT-109 or UT-110 VOICE SCRAMBLER UNIT is required.

The [Scrambler] switch is assigned in **Key assign** in **4-2 KEY & DISPLAY ASSIGN** (p. 11).

Go to 4-2 KEY & DISPLAY ASSIGN

• Scrambler— Code

Enter voice scrambling code within 1–32 using UT-109 or UT-110 with 'Non-rolling' selection or within 1–255 using UT-110 with 'Rolling' selection installed.

In addition, the **Scrambler Group Code** in **4-7 COMMON** (p. 19) must be programmed when UT-110 is installed and 'Rolling' is selected in **Scrambler Type** in **4-7 COMMON** (p. 19).

Go to Scrambler Group Code

Go to Scrambler Type

4-2 KEY & DISPLAY ASSIGN

Key & Display Assign 1			Key & Display Assign 2	
Key Assign	(■)	Moni	Mic Function	OFF
	* (<)	High/Low	RF PWR(H/L)	MR CH Individual
NOTE:*	(P0)	Keyboard Lock	Backlight	Auto
Keypad	(P1)	Beep	Opening Text	
type	(P2)	Null	LCD Contrast	2:Normal
only	(P3)	Null	LCD Display	-----
	* (A)	Null	Beep ON/OFF	ON
at RX	* (B)	Null	MR-CH Bank/Free	Bank(16CH*2Bank)
only	* (C)	Null		
	* (D)	Null		
	(Up/Dn)	Up/Dn		

- Key assign— (■), *(<), (P0), (P1), (P2), (P3), *(A), *(B), *(C), *(D), (Up/Dn)

Assign a function for each programmable switch. Assignable functions and actions are as follows.

Assigned functions to (A), (B), (C) and (D) switches activate in receive mode only.

*Not available for the IC-F3S and IC-F4S.

IMPORTANT for SmarTrunk II™ OPERATION!

DO NOT assign the specified functions to the *(A), *(B), *(C) and *(D) switches when programming for SmarTrunk II™ operation, due to fact that the Speed Dial function is assigned for these switches.

Null : No function is assigned. However, lights LCD backlight for 5 sec. when 'Auto' is selected in **Backlight** (p. 12) in this screen.

Go to Backlight

Light : switches LCD backlight ON and OFF.

Bank Up : Changes memory channel bank for when either Bank (8CH*4Bank), Bank (16CH*2Bank) or Bank (20CH+12CH) is selected in the **MR-CH Bank/Free** (p. 12) in this screen.

Go to MR-CH Bank/Free

Scan A, Scan B:

When the power ON scan function is turned OFF;

Push to start and cancel scanning operation. In case of transmission during scan, cancels scanning when in Scan A, and pauses scanning, then resumes scanning after passing the time period specified in **Auto Reset** in **4-1 MEMORY CH** (p. 7) when Scan B is selected.

The scanning channel can be added or deleted to/from the scanning channel list by pushing and holding the switch only for Tag (Ena) or "blank" (Ena) in selected channels, programmed in **Scan** in **4-1 MEMORY CH**, (p. 7).

When the power ON scan function is turned ON;

Push to pause scanning when in Scan A, and push to cancel scanning when Scan B is selected. In case of transmission during scan, pauses scanning, then resumes scanning after passing the time period specified in the **Auto Reset** in **4-1 MEMORY CH** (p. 7) when in Scan A. Cancels scanning when Scan B is selected.

While pausing scan when in Scan A, or after cancelling scan when Scan B is selected, the scanning channel can be added or deleted to/from the scanning channel list by pushing and holding the switch only for Tag (Ena) or "blank" (Ena) in selected channels, programmed in **Scan** in **4-1 MEMORY CH**, (p. 7).

The power ON scan function is specified in **PWR ON Scan** in **4-5 SCAN FUNCTION** (p. 14).

NOTE: Scan A and Scan B cannot be assigned at the same time, because the transceiver cannot have two different scans.

Go to Auto Reset

Go to Scan

Go to PWR ON Scan

Priority CH (Rewrite):

Selects the priority channel programmed in **CH Atr** in **4-1 MEMORY CH** (p. 5). Also re-assigns priority channel by pushing and holding the switch.

Go to CH Atr

Moni : Push to mutes the CTCSS, DTCS or 2-tone squelch, push for 1 sec. to releases the CTCSS, DTCS or 2-tone squelch mute. Open any squelches/deactivate any mutes while pushing this switch.

4-2 KEY & DISPLAY ASSIGN— continued

Key & Display Assign 1			Key & Display Assign 2	
Key Assign	(■)	Moni	Mic Function	OFF
	* (<)	High/Low	RF PWR (H/L)	MR CH Individual
NOTE:*	(P0)	Keyboard Lock	Backlight	Auto
Keypad	(P1)	Beep	Opening Text	
type	(P2)	Null	LCD Contrast	2:Normal
only	(P3)	Null	LCD Display	-----
	* (A)	Null	Beep ON/OFF	ON
at RX	* (B)	Null	MR-CH Bank/Free	Bank (16CH*2Bank)
only	* (C)	Null		
	* (D)	Null		
	(Up/Dn)	Up/Dn		

Emergency Repeat, Emergency Single:

Immediately selects emergency channel and automatically sends a repeated emergency signal at specified time intervals or an emergency signal once, by pushing and holding the switch.

This function cannot be assigned to [A]–[D] switches.

The emergency channel is specified in **CH Atr** in *4-1 MEMORY CH* (p. 5) and the time intervals are specified in the **Emer Start/Repeat** in *4-8 EXPERT* (p. 20).

Go to CH Atr

Go to Emer Start/Repeat

Keyboard Lock:

Switches keyboard lock function ON and OFF.

Beep : Switches key touch beep ON and OFF.

Shift : Shifts the CPU's clock frequency by pushing and holding the switch.

Scrambler:

Switches voice scrambler function ON and OFF when an optional voice scrambler unit, UT-109 or UT-110, is installed.

OPT1 Out:

Switches an optional output port High and Low.

OPT1 Momentary Out:

Outputs a High or Low pulse from an optional output port.

Trunking Group SW:

Selects trunking group.
This function is used for the SmarTrunk II™ operation only.

Turbo Speedial A, B, C, D:

Immediately calls commonly used telephone or subscriber numbers during SmarTrunk operation. See page 44 for details

This function is used for the SmarTrunk II™ operation only.

Programming memory Speed Dial

- ① Push and hold the [*] until a high-pitch beep is heard.
 - ② Enter the memory location (0–9, A, B, C, D), the telephone or subscriber number, then [1], [*] (or [3], [*] if for another system subscriber).
 - A high-pitch beep informs successful programming.
 - Memories [A]–[D] are used for the Turbo Speedial.
- Note: This function is available for the IC-F3/F4 only.

• Mic Function

Selects remote control capability from an optional HM-75A SPEAKER MICROPHONE.

[▲], [▼], [A] and [B] switches on the HM-75A operate as [▲], [▼], [A] and [B] switches on the transceiver, respectively.

When using with IC-F3S or IC-F4S, [A] and [B] switches on the HM-75A operate with the function assigned in the *(A) and * (B) in this screen, respectively.

at RX	* (A)	Null
	* (B)	Null

• RF PWR (H/L)

Selects transmit output power setting condition from MR CH Individual and Override.

The selected transmit output power level via [High/Low] switch is kept for all channels regardless of the individual power setting programmed in **RF PWR** in *4-1 MEMORY CH* (p. 6) when 'Override' is selected. However, the selected transmit output power level via [High/Low] switch is output temporarily when "MR CH Individual" is selected.

Go to RF PWR

4 SCREEN MENU OPERATION— LMR

4-2 KEY & DISPLAY ASSIGN— continued

Key & Display Assign 1			Key & Display Assign 2	
Key Assign	(■)	Moni	Mic Function	OFF
	* (<)	High/Low	RF PWR(H/L)	MR CH Individual
NOTE: *	(P0)	Keyboard Lock	Backlight	Auto
Keypad	(P1)	Beep	Opening Text	
type	(P2)	Null	LCD Contrast	2:Normal
only	(P3)	Null	LCD Display	-----
	* (A)	Null	Beep ON/OFF	ON
at RX	* (B)	Null	MR-CH Bank/Free	Bank(16CH*2Bank)
only	* (C)	Null		
	* (D)	Null		
	(Up/Dn)	Up/Dn		

• Backlight

Selects LCD backlight lighting condition from Auto, Continuous and OFF.

Auto : Lights for 5 sec. when any switch except [PTT] is pushed.

Continuous:

Lights continuously while the transceiver is powered ON.

OFF : Does not light with any operation.

• Opening Text

Enter up to a 7-character transceiver opening message.

The usable characters are A–Z (uppercase), 0–9, \$, ‘, (,), -, /, <, =, >, @, [, \,], _, |, ~.

• LCD Contrast

Selects LCD contrast level from 1: Low and 2: Normal.

• Beep ON/OFF

Selects key-touch beep output capability. (Not for lock-out timer, TOT, etc.)

• MR-CH Bank/Free

Selects memory channel combination from Bank (8CH*4Bank), Bank (16CH*2Bank), Bank (20CH+12CH) and Free.

Bank (8CH*4Bank), Bank (16CH*2Bank) or Bank (20CH+12CH) divides all available 32 channels into 4, 2 channels groups or 20 channels plus 12 channels, respectively.

Free— channels can be used continuously.

4-3 DTMF AUTODIAL

DTMF Autodial	
No.	Code Text
1	
2	
3	
Emergency	
Log / ID	
DTMF Timer 0.100	
1st Timer 0.100	
[*] [#] Timer 0.100	

• Code

Enter up to a 24-digit DTMF code for simple and quick DTMF code transmission.

The usable characters are 0–9, A–F (#/* used as F/E).

• Text

Enter up to a 7-character text for easy recognition of DTMF code usage, etc.

When no text is programmed, the programmed DTMF code is scrolled.

The usable characters are A–Z (uppercase), 0–9, \$, ' , (,) , - , / , < , = , > , @ , [, \ ,] , _ , | , ~.

• DTMF Timer

Enter time period/signal length for each DTMF code emission and interval.

• 1st Timer

Enter time period/signal length for 1st DTMF code emission and interval corresponding to the scanning or power saving of the transceiver.

• [*] [#] Timer

Enter time period/signal length for [*] and [#] DTMF code signal emission and interval.

These codes may be used for control codes depending on signaling system.

When these special codes are used for the 1st digit code, the **1st Timer** as above has priority over this setting.

4-4 CONTINUOUS TONE

Continuous Tone		
No.	RX	TX
Tone 1		
2		
3		
4		
5		
6		
7		
8		
9		

• RX and TX

Enter full CTCSS frequency for each RX and TX as instructed in the **CTCSS/DTCS— RX and TX** in **4-1 MEMORY CH** (p. 5).

Go to CTCSS/DTCS— RX and TX

The programmed continuous tone combinations can be used for temporary or permanent encoder and/or decoder operation.

Temporary operation;

Push [C. Tone CH Ent] switch, then select a continuous tone memory channel via [▲] or [▼] switch.

Permanent operation;

Select a continuous tone memory channel via [▲] or [▼] switch, while pushing and holding [C. Tone CH Ent] switch.

The [C. Tone CH Ent] switch is assigned in **4-2 KEY & DISPLAY ASSIGN** (p. 10).

Go to 4-2 KEY & DISPLAY ASSIGN

4 SCREEN MENU OPERATION— LMR

4-5 SCAN FUNCTION

Scan Function	
Mode	M1 (Normal)
Text	
PWR Save	ON
Stop Timer	5.000
Resume Timer	3.000
PWR ON Scan	OFF

• Mode

Selects scanning mode from the Mode 1, 2, 3 and OFF.

Mode 1 : Normal scan. Scans all 'Tag (Inh)' or 'Tag (Ena)' selected channels. The scan proceeds in sequence from lower to higher channel number.

Mode 2 : Priority scan. The priority channel is monitored every fixed time period during scan (depending on version), or every specified time period programmed in the **Stop Timer** in this screen, as at right, during pause. The busy or paused channel is retained when scan is cancelled.

Mode 3 : Priority scan. Same scanning sequence as Mode 2 above. The priority channel is retained when scan is cancelled.

OFF : Scan function cannot be controlled from the transceiver keypad.

The scanning channels, 'Tag (Inh)' or Tag '(Ena)', are selected in **Scan** in **4-1 MEMORY CH** (p. 7).

The priority channel is selected in **CH Atr** in **4-1 MEMORY CH** (p. 5).

Go to Scan
Go to CH Atr

• Text

Enters up to a 7-character text to indicate messages, etc. during scanning.

When no text is programmed, scanning channel text or number is scrolled.

The usable characters are A–Z (uppercase), 0–9, \$, ' , (,) , - , / , < , = , > , @ , [, \ ,] , _ , | , ~.

• PWR Save

Selects power save capability during scanning.

Total scanning speed is decreased when the function is turned ON.

• Stop Timer

Enters time period for scan pausing on a busy channel (watching interval) when receiving a signal in scan mode 2 or 3 (priority scan), specified in **Mode** as at above left.

• Resume Timer

Enters time period for resuming scanning after signal disappears.

• PWR ON Scan

Selects automatic scan start capability at power ON from ON and OFF.

Also, automatically restarts scanning even once scanning is cancelled for call transmission or reception, etc., after a specified time has passed when the signal disappears or key operation is finished when ON is selected.

When SmarTrunk ON/OFF is selected in **CH Atr** in this screen (p. 5), "OFF" must be selected.

The scanning restart condition is selected in **Auto Reset** in **4-1 MEMORY CH** (p. 7), and the time period is programmed in the **Auto Reset— Timer A, Timer B** in **4-7 COMMON** (p. 17).

Go to CH Atr

Go to Auto Reset

Go to Auto Reset— Timer A, Timer B

4-6 2TONE CODE CH

CH No.	Group		2Tone Code CH			
	Call	Text	Bell	ANS	Beep	Stun Scan
1	2nd	CALL1	ON		PiRo	
2	2nd	CALL2	ON		PiRo	
3	2nd	CALL3	ON		PiRo	
G	---	GROUP	Blink		PiPi	

Beep Repeat Timer	10.000
Group Timer	3.000
2nd Tone Length	1.000

• **Group Call**

Selects which tone digit, 1st or 2nd, is used for the group code.

• **Text**

Enter up to a 7-character text into the column directly. The programmed text appears when a matched 2-tone code signal is received.

The usable characters are A–Z (uppercase), 0–9, \$, ' , (,) , - , / , < , = , > , @ , [, \ ,] , _ , | , ~.

• **Bell**

Selects the bell indicator condition when receiving a matched 2-tone from ON, Blink, Null, and OFF.

- ON : The bell indicator appears until operation of key.
- Blink : The bell indicator blinks until operation of key.
- Null : The bell indicator condition is not changed even when a matched code is received.
- OFF : The bell indicator goes off.

• **ANS**

Turns the answer back function ON and OFF. The function transmits a 1 kHz single tone for 2 sec. when receiving a matched 2-tone.

• **Beep**

Selects beep type when matched 2-tone code is received from Pi, PiPi, PiRo, Pi/R, PiPi/R, PiRo/R, Null and OFF.

- Null : Beep emission (or non emission) is retained even when matched 2-tone is received.
- OFF : Repeated beep emission is turned OFF.
- Pi : 1 high beep once.
- PiPi : 2 high beeps once.
- PiRo : 1 high and 1 low beep 3 times.
- Pi/R : 1 high beep repeated at the specified time period.
- PiPi/R : 2 high beeps repeated at the specified time period.
- PiRo/R : 1 high, 1 low beep 3 times, repeated at the specified time period.

The repeating time period is programmed in the **Beep Repeat Timer** (p. 16) in this screen.

Go to Beep Repeat Timer

• **Stun**

Selects transceiver's basic condition when matched 2-tone code is received from Kill, Stun and OFF.

- Kill : The transceiver cannot be used. Cloning is necessary to activate the transceiver.
- Stun : A message, "SORRY", appears and transceiver cannot be used. To use the transceiver, turn power OFF and ON again. At this time, password input is necessary if the power ON password is programmed in **User Password** in **4-7 COMMON** (p. 17).
- OFF : The transceiver can be used continuously.

Go to User Password

4 SCREEN MENU OPERATION— LMR

4-6 2TONE CODE CH— continued

CH No.	Group Call	Text	2Tone Bell	Code ANS	CH Beep	Stun	Scan
1	2nd	CALL1	ON		PiRo		
2	2nd	CALL2	ON		PiRo		
3	2nd	CALL3	ON		PiRo		
G	---	GROUP	Blink		PiPi		

Beep Repeat Timer	10.000
Group Timer	3.000
2nd Tone Length	1.000

• Scan

Selects scanning condition when a matched 2-tone code is received from Cancel, Start and Null.

Cancel : Cancels the scan.

Start : Starts the scan.

Null : Scan condition is unaffected.

The cancelled or started scan type and conditions are specified in **4-5 SCAN FUNCTIONS** (p.14), and the scanning can be restarted or cancelled via [Scan] switch, assigned in **4-2 KEY & DISPLAY ASSIGN** (p. 9).

Go to 4-5 SCAN FUNCTIONS

Go to 4-2 KEY & DISPLAY ASSIGN

• Beep Repeat Timer

Enters beep emission repeating time period.

When "Pi/R", "PiPi/R" or "PiRo/R" is selected in **Beep** in this screen (p. 15), beeps are repeated at this period.

Go to Beep

• Group Timer

Enter time period for group tone decoding.

The transceiver reads the tone as a group code in the case that the received tone is longer than the programmed time period.

• 2nd Tone Length

Enter time period for 2nd digit tone decoding within 0–2.55 sec.

4-7 COMMON

Common 1		Common 2	
User Password	1234	PWR ON Password	OFF
Clone Comment		Transceiver Data Out	Enabled
Auto Reset Timer A	30.000	Scrambler Type	Rolling
Timer B	OFF	Scrambler Group Code	1
Inactive Timer	-----	Synchronous Capture	Standard
TOT Timer	30.000	Tone Start Timing	OFF
Penalty Timer	20.000		
ID Out (DTMF)	OFF		
Beep	OFF		
Lockout Penalty Timer	5.000		
CTCSS Reverse Burst	0.400		

• **User Password**

Enters up to a 4-digit user password for the power ON password function or for cancelling the “Stun” condition.

The power ON password function is specified in **PWR ON Password** in this screen (p. 18), and the “Stun” function is specified in **Stun** in **4-6 2TONE CODE CH** (p. 15).

Go to Power ON Password

Go to Stun

• **Clone Comment**

Enters up to a 16-character text for quick identification of a transceiver’s content.

The programmed comment of connected transceiver can be checked without reading all other existing programmed data. See page 44, **6-3 INFORMATION**, for details.

The programmed comment of saved programming data can also be checked in the file table.

See page 4, **3 FILE MENU OPERATION** for details.

Go to 6-3 INFORMATION

Go to 3 FILE MENU OPERATION

• **Auto Reset— Timer A, Timer B**

Enter time period for restarting the scan from a disappearing signal or when key operation is finished.

To turn OFF the Auto Reset function, enter “0 (zero)” to one of these settings. (“OFF” will be indicated)

The programmed settings are selected in **Auto Reset** in **4-1 MEMORY CH** (p. 7) and are related with the **PWR ON Scan** in the **4-5 SCAN FUNCTION** (p. 14).

Go to Auto Reset

Go to PWR ON Scan

• **TOT— Timer**

Enters continuously transmittable time period (Time-out timer). Maximum time period is specified for 30, 60 or 180 sec., etc. according to country, local regulation.

The time-out timer function can be turned ON or OFF for each operating channel in **TOT** in **4-1 MEMORY CH** (p. 6).

DO NOT set to only a few seconds, as transmitting will be impossible.

Go to TOT

• **TOT— Penalty Timer**

Enters un-transmittable time period for penalty when continuously transmitted time has exceeded the specified time period programmed in **TOT— Timer** as above.

The TOT penalty time is the transmit inhibit period when the time-out timer is activated.

• **TOT— ID Out (DTMF)**

Selects automatic ID transmission capability from ON and OFF.

The function automatically transmits an ID code when the time-out timer activates and just before transmission is inhibited.

The ID code is programmed in *No. Log/ID* in **4-3 DTMF AUTODIAL** (p.13).

Go to DTMF AUTODIAL

4 SCREEN MENU OPERATION— LMR

4-7 COMMON— Continued

Common 1		Common 2	
User Password	1234	PWR ON Password	OFF
Clone Comment			
Auto Reset Timer A	30.000	Transceiver Data Out	Enabled
Timer B	OFF		
Inactive Timer	-----	Scrambler Type	Rolling
TOT Timer	30.000	Scrambler Group Code	1
Penalty Timer	20.000	Synchronous Capture	Standard
ID Out (DTMF)	OFF	Tone Start Timing	OFF
Beep	OFF		
Lockout Penalty Timer	5.000		
CTCSS Reverse Burst	0.400		

• TOT— Beep

Selects warning beep output capability for TOT function. Emits warning beep 10 sec. before compulsory shut down of the transmission.

The transceiver emits warning beeps 10 sec. before , and the time-out timer activates when this setting is turned ON.

• Lockout Penalty Timer

Enters un-transmittable time period for penalty when transmitted on busy channel. The un-transmittable condition is kept for the programmed time period even if the channel is cleared.

The lockout penalty time is the transmit inhibit period when the user attempts to transmit while in a lockout condition. The transmission is inhibited for the lockout penalty time even when the lockout condition is cleared.

• CTCSS Reverse Burst

Enters time period for transmission delay with [PTT] switch operation and CTCSS signal.

The transceiver still transmits for the programmed period without the CTCSS encoder after [PTT] is released. This removes the transceiver's 'Squelch delay'.

• CTCSS Reverse Burst

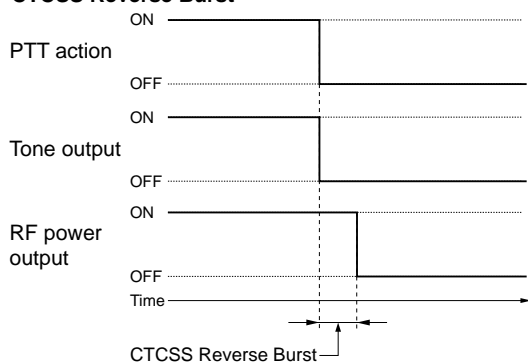

• PWR ON Password

Selects power ON password function capability from ON and OFF.

When the function is turned ON it is necessary to enter the 4-digit password programmed in the **User Password** (p. 17) in this screen. However, the password must be entered after receiving a "Stun" signal regardless of this setting.

The Stun condition is programmed in **Stun** in **4-6 2TONE CODE CH** (p. 15).

Go to User Password

Go to Stun

• Transceiver Data Out

Selects transceiver's programmed data out capability by both using this software and cloning between transceivers from Enable and Disable.

The setting does not inhibit data writing, therefore over writing data is still possible even when Disable is selected.

4-7 COMMON— Continued

Common 1		Common 2	
User Password	1234	PWR ON Password	OFF
Clone Comment			
Auto Reset Timer A	30.000	Transceiver Data Out	Enabled
Timer B	OFF		
Inactive Timer	-----	Scrambler Type	Rolling
TOT Timer	30.000	Scrambler Group Code	1
Penalty Timer	20.000	Synchronous Capture	Standard
ID Out (DTMF)	OFF	Tone Start Timing	OFF
Beep	OFF		
Lockout Penalty Timer	5.000		
CTCSS Reverse Burst	0.400		

• **Scrambler Type**

Selects scrambler type from Rolling and Non-rolling. Selects Rolling when the optional voice scrambler unit, UT-110 (#01), is installed, selects Non-rolling when UT-109 is installed.

UT-110 and UT-109 are not compatible due to different scrambling systems. However, UT-110 can be used instead of UT-109 by selecting Non-rolling type in this item

The **Scrambler Group Code** as follows must be programmed when UT-110 is used with Rolling setting.

• **Scrambler Group Code**

Selects scrambler group code from 1, 2, 3 and 4 when the optional voice scrambler unit, UT-110 (#01), is installed and Rolling is selected in the **Scrambler Type** as above.

It is not required to program when the optional voice scrambler unit, UT-109, is installed.

• **Synchronous Capture**

Selects synchronous capture mode from Standard and Continuous.

It is recommended that Standard is selected for simplex/normal operation, Continuous for repeater operation.

• **Tone Start Timing**

Selects reference tone signal delay time from OFF, 0.3sec., 0.6 sec. and 1.1 sec.

The setting is used to synchronize voice scrambling timing when the other stations/transceivers are in power save mode.

4 SCREEN MENU OPERATION— LMR

4-8 EXPERT

Expert	
Fast Scan Timer	0.100
Slow Scan Timer	0.500
TX DTCS Inverse	Normal
RX DTCS Inverse	Normal
Emer SW ON Timer	2.000
SW OFF Timer	1.000
Start/Repeat	10.000
PWR Save Start Timer (1st)	5.000
Timer (2nd)	60.000
Low Beep Frequency	500
High Beep Frequency	1000

• Fast Scan Timer

Enters time period for scanning of each channel without CTCSS/DTCS programming.

An appropriate time is set by default and scan may not stop when setting a value less than the default.

• Slow Scan Timer

Enters time period for scanning of each channel with CTCSS/DTCS programming.

An appropriate time is set by default and scan may not stop when setting a value less than the default.

• TX DTCS Inverse

Selects the transmit DTCS code polarity.

In order for the transceiver to communicate using a DTCS code, the polarity of the transmitting transceiver's transmit code must be the same as the polarity of the receiving transceiver's receive code.

• RX DTCS Inverse

Selects the receive DTCS code polarity.

In order for transceivers to communicate using DTCS codes, the polarity of the receiving transceiver's receive code must be the same as the polarity of the transmitting transceiver's transmit code.

• Emer SW ON Timer

Enters time period for which [Emergency Repeat] or [Emergency Single] switch must be held to activate the emergency function.

Push and hold [Emergency Repeat] or [Emergency Single] switch for the programmed time period to make an emergency call.

• Emer SW OFF Timer

Enters time period for which [Emergency Repeat] or [Emergency Single] switch must be held to cancel the emergency function.

Push and hold [Emergency Repeat] or [Emergency Single] switch for the programmed time period to cancel an emergency call before an emergency signal is transmitted.

However, once an emergency call is transmitted, the call cannot be cancelled regardless of this setting.

• Emer Start/Repeat

Enter the time periods for the emergency call delay and interval.

The transceiver makes an emergency call after passing the programmed time period when the emergency function is activated.

The transceiver transmits an emergency signal repeatedly at this interval until an "Emergency Cancel" code is received when [Emergency Repeat] is used.

• PWR Save Start Timer (1st), (2nd)

Enter the time period for the power saver function start timers within 0–25.5 sec. for the 1st, and 1–255 sec. or OFF (enter 'OFF', when 'OFF' is selected) for the 2nd timer.

The 1st timer must be set smaller than the 2nd timer, due to the fact that the 2nd timer/power saver function activates after the 1st timer/power saver. Otherwise the 1st timer does not activate. The 2nd timer will be set to 'OFF' when the UT-110 voice scrambler unit is installed. The long timer setting will be invalid.

• Low Beep Frequency, High Beep Frequency

Enter beep audio frequency for each Low (for error) and High (for regular) beep within 400 to 2998 Hz range, respectively.

The nearest available frequency is selected automatically.

5-1 MEMORY CH

Bnk	CH	Frequency (MHz)		CTCSS/DTCS		Text	PWR Save	TOT	RF Lock	Scan	SW Act
		RX	TX	RX	TX						
1	Atr										Moni
. 1											
. 2											
. 3											
. 4											
. 5											
. 6											
. 7											
. 8											
. 9											
.10											
.11											
.12											
.13											
.14											
.15											
.16	P										

• CH Atr

Selects the channel attribution from P (Priority), E (Emergency), and Emergency OFF.

Set the cursor to the CH Atr column, then push [Return] key to display the window as at right. Select the channel attribution by pushing [↑]/[↓] keys.

'P' : Priority
'E' : Emergency
Emergency OFF
SmarTrunk ON/OFF
Insert CH (Ins)
Delete CH (Del)
Return

P: Priority— “P” tagged channel becomes a priority channel, simply recalled by pushing [Priority CH] switch and also is automatically monitored during the priority scan. Only 1 channel can be set.

E: Emergency— “E” tagged channel becomes an emergency channel, immediately recalled and sends emergency signal by pushing [Emergency Single] or [Emergency Repeat] switch. Only 1 channel can be set.

Emergency OFF— Regular channel.

SmarTrunk ON/OFF switches SmarTrunk II capabilities. In this case, an optional UT-105 SmarTrunk II Logic Board and extra programming with an EX-2095 application in the CS-F3 are required.

See pages 46–48, **8 PROGRAMMING for SmarTrunk II OPERATION**, for details.

[Priority CH], [Emergency Single] and [Emergency Repeat] switches are assigned in **5-2 KEY & DISPLAY ASSIGN** (pgs. 28, 30).

Go to 8 PROGRAMMING for SmarTrunk II OPERATION
Go to 5-2 KEY & DISPLAY ASSIGN

• Frequency— RX and TX

Enter receive and transmit frequencies within the following frequency range in either 5, 6.25 or 7.5 kHz steps* for both the RX and TX columns, respectively.

IC-F3/S: 136–150, 146–174 MHz

IC-F4/S: 400–430, 440–470, 470–500, 490–520 MHz

*according to version

Transmit inhibit can be selected by pushing [Space] key.

When no receive frequency is entered, other data cannot be programmed into the channel.

When SmarTrunk ON/OFF is selected in **CH Atr** as at left, operating frequencies must be programmed from channel 1 without a blank.

• CTCSS/DTCS— RX and TX

Enter full CTCSS frequency (incl. decimal point; otherwise a DTCS code is entered) or a 3-digit DTCS code as well as polarity for receive and transmit in the RX and TX columns, respectively.

By pushing the [Enter] key, the CTCSS frequency list as at right appears for simple frequency selection. Also selectable with [Space] or [Back Space] keys without list indication.

DTCS	85.4	118.8	162.2	192.8	241.8
OFF	88.5	123.0	165.5	196.6	250.3
	67.0	91.5	127.3	167.9	199.5
	69.3	94.8	131.8	171.3	203.5
	71.0	97.4	136.5	173.8	206.5
	71.9	100.0	141.3	177.3	210.7
	74.4	103.5	146.2	179.9	218.1
	77.0	107.2	151.4	183.5	225.7
	79.7	110.9	156.7	186.2	229.1
	82.5	114.8	159.8	189.9	233.6

The polarity of DTCS is selectable by pushing the [Space] or [Back Space] key from N (Normal) and I (Inverse).

5 SCREEN MENU OPERATION— PMR

5-1 MEMORY CH— continued

Bnk	CH	Frequency (MHz)		CTCSS/DTCS		Text	PWR Save	TOT	RF Lock		SW Act
		RX	TX	RX	TX				PWR out	Scan	
1	Atr										
. 1											
. 2											
. 3											
. 4											
. 5											
. 6											
. 7											
. 8											
. 9											
. 10											
. 11											
. 12											
. 13											
. 14											
. 15											
. 16	P										

• Text

Enter up to a 7-character text in the Text column for memory name, channel usage, etc.

The usable characters are A–Z, 0–9, \$, ', (,), -, /, <, =, >, @, [, \,], _, | and ~.

When no text is entered, the channel number is indicated.

To indicate the programmed text, 'Text' must be selected in **LCD Display** in **5-2 KEY & DISPLAY ASSIGN** (p. 31).

Go to LCD Display

• PWR Save

Selects power save capability from ON and OFF.

When SmarTrunk ON/OFF is selected in **CH Atr** in this screen (p. 21), "OFF" must be selected.

The power save start timings are programmed at the **PWR Save Start Timer (1st)/(2nd)** in **5-10 EXPERT** (p. 43).

Go to CH Atr

Go to PWR Save Start Timer (1)/(2)

• TOT

Selects time-out-timer function capability from ON and OFF.

Continuously transmittable time is limited by the timer when ON is selected. However, time-out timer must be set to ON due to local regulations, in some countries.

When SmarTrunk ON/OFF is selected in **CH Atr** in this screen (p. 21), "OFF" must be selected.

The time period is programmed in the **TOT— Timer** in **5-9 COMMON** (p. 41).

Go to CH Atr

Go to TOT— Timer

• RF PWR

Selects transmit output power from H (High) and L (Low).

The selected output power setting for each channel can be switched to either temporary, or permanent, according to the setting in **RF PWR (H/L)** in **5-2 KEY & DISPLAY ASSIGN** (p. 31) via [High/Low] switch.

The [High/Low] switch is assigned in the **5-2 KEY & DISPLAY ASSIGN** (p. 29)

Go to RF PWR (H/L)

Go to 5-2 KEY & DISPLAY ASSIGN

• Lock out

Selects transmission lock out (temporary inhibit) capability from Busy, Rpt 1, Rpt 2 and OFF.

Busy : [PTT] switch cannot be activated while the operating channel/repeater is in use.

Rpt 1 : [PTT] switch can be activated while receiving a signal with matched CTCSS (or DTCS) tone or no signals.

Rpt 2 : [PTT] switch can be activated while receiving a signal with matched CTCSS (or DTCS) tone or no signals while 5-tone mute is released, or receiving an unmatched CTCSS (or DTCS) tone while 5-tone mute is activated.

OFF : No restriction for receiving a signal.

In addition, even if the channel/repeater is cleared, [PTT] switch cannot be activated for an extra time period when the lockout penalty timer, programmed in the **Lockout Penalty Timer** in **5-9 COMMON** (p. 41), is activated.

Go to Lockout Penalty Timer

5-1 MEMORY CH— continued

Bnk	TOT	RF	Lock	SW Action		Log	Auto	CH	5Tone	Signaling				
1	PWR	out	Scan	Moni	Sel	Call	PTT	IN/OFF	Reset	Mute	Form	RPT	STN	I
. 1														
. 2														
. 3														
. 4														
. 5														
. 6														
. 7														
. 8														
. 9														
.10														
.11														
.12														
.13														
.14														
.15														
.16														

• Scan

Selects scanning condition with permission from scanning list modification from “Blank” (Inh), “Blank” (Ena), Tag (Inh) and Tag (Ena).

Tag (Inh) or Tag (Ena) selected channels are scanned. “Blank” (Ena) or Tag (Ena) selected channels can be added or deleted to/from scan list by pushing and holding [Scan] switch.

When SmarTrunk ON/OFF is selected in **CH Atr** in this screen (p. 21), “Blank” (Inh) must be selected.

[Scan] switch is assigned in the **5-2 KEY & DISPLAY ASSIGN** (p. 28)

Go to CH Atr

Go to 5-2 KEY & DISPLAY ASSIGN

• SW Action— Moni

Selects [Moni] switch action from Aud, In_A, In_A+R, Both, Both+R and OFF.

Aud : Releases the 5-tone mute only when ‘SGL’ is selected in **CH Mute** (p. 26) in this screen, by pushing the switch for 1 sec.. Both CTCSS/DTCS and noise squelch mutes are released (audio is emitted) while pushing and holding the switch when 5-tone mute is released or ‘CONT’ is selected in **CH Mute** (p. 26) in this screen.

In_A : Mutes the 5-tones when ‘SGL’ is selected in **CH Mute** (p. 26) in this screen by pushing the switch. Both CTCSS/DTCS and noise squelch mutes are released (audio is emitted) while pushing and holding the switch while 5-tone mute is activated.

In_A+R : In addition to the ‘In_A’ condition as at below left, a reset code is automatically transmitted when call transmission is performed or 5-tone mute is activated by pushing the switch.

Both : Mutes the 5-tones when ‘SGL’ is selected in **CH Mute** (p. 26) in this screen by pushing the switch.

Releases 5-tone mute when ‘SGL’ is selected in **CH Mute** (p. 26) in this screen by pushing the switch for 1 sec.

Releases all mute controls and emits audio while pushing and holding the switch.

Both+R : In addition to the ‘Both’ condition as above, a reset code is automatically transmitted when call transmission is performed or 5-tone mute is activated by pushing the switch.

OFF : Releases both noise and CTCSS/DTCS squelch mute while pushing and holding the switch. There is no audio output when 5-tone mute is activated on the channel.

The [Moni] and [Call] switches are assigned in the **5-2 KEY & DISPLAY ASSIGN** (pgs. 28, 29).

The reset code is programmed in **5-7 TX CODE CH** (p. 37), and channel 24 is used.

The mute condition will be returned to initial condition when the Auto Reset timer is activated, specified in **Auto Reset** in this screen (p. 25).

Go to CH Mute

Go to 5-2 KEY & DISPLAY ASSIGN

Go to 5-7 TX CODE CH

Go to Auto Reset

5 SCREEN MENU OPERATION— PMR

5-1 MEMORY CH— continued

Bnk	TOT	RF	Lock	SW Action		Log	Auto	CH	5Tone	Signaling				
1	PWR	out	Scan	Moni	Sel	Call	PTT	IN/OFF	Reset	Mute	Form	RPT	STN	I
. 1														
. 2														
. 3														
. 4														
. 5														
. 6														
. 7														
. 8														
. 9														
. 10														
. 11														
. 12														
. 13														
. 14														
. 15														
. 16														

• SW Action— Sel

Selects mute condition after memory channel selection from Aud, In_A and OFF.

Aud : Releases the 5-tone mute when 'SGL' is selected in **CH Mute** (p. 26) in this screen by pushing the switch.

In_A : Mutes the 5-tones when 'SGL' is selected in **CH Mute** (p. 26) in this screen by pushing the switch.

OFF : Does not change even when selecting the channel.

The mute condition will be returned to initial condition when the Auto Reset timer is activated, specified in **Auto Reset** in this screen (p. 25).

Go to CH Mute
Go to Auto Reset

• SW Action— Call, PTT

Selects mute condition after [Call] and [PTT] switches action from Aud and OFF.

Aud : Releases the 5-tone mute when 'SGL' is selected in **CH Mute** (p. 26) in this screen after any [Call]/[PTT] transmission.

OFF : Does not change when transmitting with [Call]/[PTT] transmission.

Select OFF for both the SW Action— Call and PTT, when the **ABC Aud** in **5-7 TX CODE CH** (p. 37) is turned ON, and select OFF for SW Action— PTT, when the **PTT Call at Inaudible** in **5-7 TX CODE CH** (p. 38) is turned ON.

The [Call] switch is assigned in the **5-2 KEY & DISPLAY ASSIGN** (p. 29).

The mute condition will be returned to initial condition when the Auto Reset timer is activated, specified in **Auto Reset** in this screen.

Go to CH Mute
Go to ABC Aud
Go to 5-2 KEY & DISPLAY ASSIGN
Go to Auto Reset

5-1 MEMORY CH— continued

Bnk	ion	Log	Auto	CH	5Tone	Signaling	(R-NR)	Scrambler
1	Sel Call	PTT IN/OFF	Reset	Mute	Form	RPT STN ID	Pos RX C-No	ON/OFF Code
. 1	*****	*****	*****	*****	*****	*****	*****	*****
. 2	*****	*****	*****	*****	*****	*****	*****	*****
. 3	*****	*****	*****	*****	*****	*****	*****	*****
. 4	*****	*****	*****	*****	*****	*****	*****	*****
. 5	*****	*****	*****	*****	*****	*****	*****	*****
. 6	*****	*****	*****	*****	*****	*****	*****	*****
. 7	*****	*****	*****	*****	*****	*****	*****	*****
. 8	*****	*****	*****	*****	*****	*****	*****	*****
. 9	*****	*****	*****	*****	*****	*****	*****	*****
. 10	*****	*****	*****	*****	*****	*****	*****	*****
. 11	*****	*****	*****	*****	*****	*****	*****	*****
. 12	*****	*****	*****	*****	*****	*****	*****	*****
. 13	*****	*****	*****	*****	*****	*****	*****	*****
. 14	*****	*****	*****	*****	*****	*****	*****	*****
. 15	*****	*****	*****	*****	*****	*****	*****	*****
. 16	*****	*****	*****	*****	*****	*****	*****	*****

• **Log IN/OFF**

Selects automatic ID transmission condition in relation to [PTT] switch from L-IN, L-INA, L-INI, L-OFF, L-OFFA, Both, BothA1, BothA2 and OFF.

- L-IN : ID is transmitted when [PTT] is pushed.
- L-INA : ID is transmitted when [PTT] is pushed while 5-tone mute is released.
- L-INI : ID is transmitted when [PTT] is pushed while 5-tone mute is activated. Voice transmission is impossible while 5-tone mute is activated and 'SGL' is selected in **CH Mute** (p. 26) in this screen.
- L-OFF : ID is transmitted when [PTT] is released.
- L-OFFA : ID is transmitted when [PTT] is released while 5-tone mute is released.
- Both : ID is transmitted when both [PTT] is pushed and released.
- BothA1 : ID is transmitted when both [PTT] is pushed and released while 5-tone mute is released.
- BothA2 : ID is transmitted when both [PTT] is pushed and released while 5-tone mute is released. ID is transmitted when [PTT] is pushed while 5-tone mute is activated. Voice transmission is impossible while 5-tone mute is activated and when 'SGL' is selected in **CH Mute** (p. 26) in this screen.
- OFF : No ID is transmitted with [PTT].

When SmarTrunk ON/OFF is selected in **CH Atr** in this screen (p. 21), "OFF" must be selected.

The ID code is assigned in the **5Tone signaling— ID** column in this screen (p. 26), and the 5-tone code is programmed programmed in **5-7 TX CODE CH** (p. 37).

Go to CH Mute
Go to CH Atr

Go to 5Tone signaling— ID
Go to 5-7 TX CODE CH

• **Auto Reset**

Selects reset timer from Tim-A, Tim-B, TimAI and TimBI.

Tim-A, Tim-B:

Returns 5-tone mute condition to initial, and starts scanning, if power ON scan function is tuned ON, after specified time (Timer A or B) has passed from a disappearing signal, or when keyed operation is finished.

TimAI, TimBI:

Returns 5-tone mute condition to initial in shorter time period (either Timer A/B or Inactive) has passed from 5-tone mute is released. Automatically returns 5-tone mute condition to initial as soon as transmission is finished, and starts scanning after specified time (Timer A or B) has passed.

5-tone mute initial condition is selected in **CH Mute** as follows.

The time period of Timer A, Timer B and inactive timer is programmed in the **Auto Reset— Timer A, Timer B** and **Inactive Timer** in **5-9 COMMON** (p. 40), respectively.

Go to Auto Reset— Timer A, Timer B
Go to Inactive Timer

5 SCREEN MENU OPERATION— PMR

5-1 MEMORY CH— continued

Bnk	ion	Log	Auto	CH	5Tone	Signaling	(R-NR)	Scrambler
1	Sel Call	PTT	IN/OFF	Reset	Mute	Form	RPT STN ID	Pos RX C-No ON/OFF Code
. 1								
. 2								
. 3								
. 4								
. 5								
. 6								
. 7								
. 8								
. 9								
. 10								
. 11								
. 12								
. 13								
. 14								
. 15								
. 16								

• CH Mute

Selects 5-tone mute initial activity from CONT and SGL.

- CONT : 5-tone mute is released.
- SGL : 5-tone mute is activated. In this case, [PTT] switch action is inhibited while 5-tone mute is activated.

• 5Tone signaling— Form

Selects 5-tone system format from CCIR, ZVEI1, ZVEI2, DZVEI, EEA, EEA2, DAPL, EIA and DTMF.

• 5Tone signaling— RPT, STN, ID

Selects 5-tone code channel for repeater (RPT), individual station/group (STN) access and own identity (ID), respectively.

Also selects long tone capability if necessary by pushing the [Space] key (“L” will appear).

These 5-tone codes are programmed in **TX Code** (p. 37) and tone period for the long tone is programmed in **Long Tone Timer** in **5-7 TX-CODE CH** (p. 37).

Go to TX Code
Go to Long Tone Timer

• 5Tone signaling— Pos

Selects the own ID code sending sequence from BTM, TOP and OFF.

- BTM : Sends the ID code after sending station or group code.
- TOP : Sends the ID code before sending station or group code.
- OFF : Does not send the ID code.

• ID code sending sequence diagram

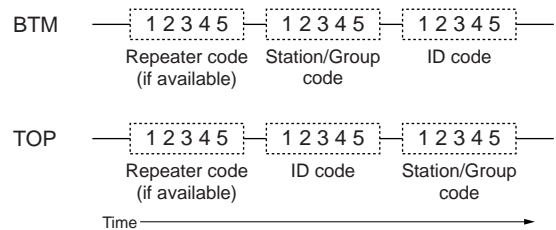

• RX C-No (R-NR)

Selects decoding 5-tone code channels. Up to 8 codes/channels can be selected to decode in each operating channel. The 5-tone code is programmed in **RX Code** in **5-6 RX CODE CH** (p. 34).

Go to RX Code

5-1 MEMORY CH— continued

Bnk	ion	Log	Auto	CH	STone	Signaling	(R-NR)	Scrambler
1	Sel Call	PTT	IN/OFF	Reset	Mute	Form	RPT STN ID	Pos RX C-No ON/OFF Code
. 1	*****	*****	*****	*****	*****	*****	*****	*****
. 2	*****	*****	*****	*****	*****	*****	*****	*****
. 3	*****	*****	*****	*****	*****	*****	*****	*****
. 4	*****	*****	*****	*****	*****	*****	*****	*****
. 5	*****	*****	*****	*****	*****	*****	*****	*****
. 6	*****	*****	*****	*****	*****	*****	*****	*****
. 7	*****	*****	*****	*****	*****	*****	*****	*****
. 8	*****	*****	*****	*****	*****	*****	*****	*****
. 9	*****	*****	*****	*****	*****	*****	*****	*****
.10	*****	*****	*****	*****	*****	*****	*****	*****
.11	*****	*****	*****	*****	*****	*****	*****	*****
.12	*****	*****	*****	*****	*****	*****	*****	*****
.13	*****	*****	*****	*****	*****	*****	*****	*****
.14	*****	*****	*****	*****	*****	*****	*****	*****
.15	*****	*****	*****	*****	*****	*****	*****	*****
.16	*****	*****	*****	*****	*****	*****	*****	*****

• **Scrambler— ON/OFF/INH**

Selects voice scrambling function initial setting from ON, OFF and INH.

When ON or OFF is selected, the voice scrambling function can be manually switched with the [Scrambler] switch, however, the function cannot be manually switched ON when INH is selected.

An optional UT-109 or UT-110 VOICE SCRAMBLER UNIT is required.

The [Scrambler] switch is assigned in **Key assign** in **5-2 KEY & DISPLAY ASSIGN** (p. 29).

Go to 5-2 KEY & DISPLAY ASSIGN

• **Scrambler— Code**

Enter voice scrambling code within 1–32 using UT-109 or UT-110 with 'Non-rolling' selection or within 1–255 using UT-110 with 'Rolling' selection installed.

In addition, the **Scrambler Group Code** in **5-9 COMMON** (p. 42) must be programmed when UT-110 is installed and 'Rolling' is selected in **Scrambler Type** in **5-9 COMMON** (p. 42).

Go to Scrambler Group Code

Go to Scrambler Type

5 SCREEN MENU OPERATION— PMR

5-2 KEY & DISPLAY ASSIGN

Key & Display Assign 1		Key & Display Assign 2	
Key Assign	(■)	Moni (Audi)	
	* (<)	High/Low	
NOTE: *	(P0)	Keyboard Lock	
Keypad	(P1)	Beep	Mic Function
type	(P2)	Call	RF PWR (H/L)
only	(P3)	TX Code	Backlight
	* (A)	Null	Opening Text
at RX	* (B)	Null	LCD Contrast
only	* (C)	Null	LCD Display
	* (D)	Null	Beep ON/OFF
	(Up/Dn)	Up/Dn	MR-CH Bank/Free

- Key assign— (■), *(<), (P0), (P1), (P2), (P3), *(A), *(B), *(C), *(D), (Up/Dn)

Assign a function for each programmable switch. Assignable functions and actions are as follows.

Assigned functions to (A), (B), (C) and (D) switches activate in receive mode only.

*Not available for the IC-F3S and IC-F4S.

IMPORTANT for SmarTrunk II™ OPERATION!

DO NOT assign the specified functions to the *(A), *(B), *(C) and *(D) switches when programming for SmarTrunk II™ operation, due to fact that the Speed Dial function is assigned for these switches.

Null : No function is assigned. However, lights LCD backlight for 5 sec. when 'Auto' is selected in **Backlight** (p. 31) in this screen.

Go to Backlight

Light : Switches LCD backlight ON and OFF.

Bank Up : Changes memory channel bank for when either Bank (8CH*4Bank), Bank (16CH*2Bank) or Bank (20CH+12CH) is selected in the **MR-CH Bank/Free** (p. 31) in this screen.

Go to MR-CH Bank/Free

Scan A, Scan B:

When the power ON scan function is turned OFF;

Push to start and cancel scanning operation. In case of transmission during scan, cancels scanning when in Scan A, and pauses scanning, then resumes scanning after passing the time period specified in **Auto Reset** in **5-1 MEMORY CH** (p. 25) when Scan B is selected.

The scanning channel can be added or deleted to/from the scanning channel list by pushing and holding the switch only for Tag (Ena) or "blank" (Ena) in selected channels, programmed in **Scan** in **5-1 MEMORY CH**, (p. 23).

When the power ON scan function is turned ON;

Push to pause scanning when in Scan A, and push to cancel scanning when Scan B is selected. In case of transmission during scan, pauses scanning, then resumes scanning after passing the time period specified in the **Auto Reset** in **5-1 MEMORY CH** (p. 25) when in Scan A. Cancels scanning when Scan B is selected.

While pausing scan when in Scan A, or after cancelling scan when Scan B is selected, the scanning channel can be added or deleted to/from the scanning channel list by pushing and holding the switch only for Tag (Ena) or "blank" (Ena) in selected channels, programmed in **Scan** in **5-1 MEMORY CH** (p. 23).

The power ON scan function is specified in **PWR ON Scan** in **5-5 SCAN FUNCTION** (p. 33).

NOTE: Scan A and Scan B cannot be assigned at the same time, because the transceiver cannot have two different scans.

Go to Auto Reset

Go to Scan

Go to PWR ON Scan

Priority CH (Rewrite):

Selects the priority channel programmed in **CH Atr** in **5-1 MEMORY CH** (p. 21) by pushing the switch. Also the operating channel is re-assigned for priority channel by pushing and holding the switch.

Go to CH Atr

Moni (Audi):

Activates a monitor function specified in **Switch Action— Moni** in **5-1 MEMORY CH** (p. 23).

Go to Switch Action— Moni

5-2 KEY & DISPLAY ASSIGN— continued

Key & Display Assign 1			Key & Display Assign 2	
Key Assign	(■)	Moni (Audi)	Mic Function	OFF
	* (<)	High/Low	RF PWR (H/L)	MR CH Individual
NOTE:*	(P0)	Keyboard Lock	Backlight	Auto
Keypad	(P1)	Beep	Opening Text	
type	(P2)	Call	LCD Contrast	2:Normal
only	(P3)	TX Code	LCD Display	Text
	* (A)	Null	Beep ON/OFF	ON
at RX	* (B)	Null	MR-CH Bank/Free	Bank (16CH*2Bank)
only	* (C)	Null		
	* (D)	Null		
	(Up/Dn)	Up/Dn		

High/Low: Switches transmit output power level from the independent settings of each channel. The switched output power can be used for initial setting, when "Override" is selected in the **RF PWR (H/L)** in this screen (p. 31).

Go to RF PWR (H/L)

C. Tone CH Ent:

Selects continuous tone channel via [▲] or [▼] switch and temporarily changes the tone frequency/code setting after pushing the switch. Also changes continuous tone frequency/code setting, programmed in the **CTCSS/DTCS— RX and TX in 5-1 MEMO-RY CH** (p. 21), via [▲] or [▼] switches while pushing the switch.

The continuous tone channel is programmed in **5-4 CONTINUOUS TONE** (p. 32),

Go to CTCSS/DTCS— RX and TX

Go to 5-4 CONTINUOUS TONE

Talk Around:

Toggles the talk around function ON and OFF.

This function makes temporarily simplex operation on the duplex/repeater channel.

DTMF Autodial:

For entering the DTMF autodial mode and then transmits the stored DTMF code after a selection via [▲] or [▼] switch for each operation.

For entering the DTMF code re-programming mode by pushing and holding and then completes the setting by pushing (IC-F3/F4) or pushing and holding the (IC-F3S/F4S) switch after DTMF code has been entered as follows.

To enter DTMF code—

IC-F3/F4 ; Directly enter desired DTMF code by using [0]–[9], [A]–[D], [*] and [#] switches.

IC-F3S/F4S; Select the code number via [▲] or [▼] switches then push the switch to set the next code number.

This function cannot be assigned to [A]–[D] switches on the transceiver.

The DTMF code for auto dialling is programmed in **5-3 DTMF Autodial** (p. 32).

Go to 5-3 DTMF Autodial

Re-Dial : Transmits the last-transmitted DTMF code again. Acts for both manual DTMF and autodial.

Re-Dial will be cleared when the transceiver is turned OFF.

Call : Transmits the 5-tone code sequence in the selected channel.

5-2 KEY & DISPLAY ASSIGN— continued

Key & Display Assign 1			Key & Display Assign 2	
Key Assign	(■)	Moni (Audi)	Mic Function	OFF
	* (<)	High/Low	RF PWR (H/L)	MR CH Individual
NOTE:*	(P0)	Keyboard Lock	Backlight	Auto
Keypad	(P1)	Beep	Opening Text	
type	(P2)	Call	LCD Contrast	2:Normal
only	(P3)	TX Code	LCD Display	Text
	* (A)	Null	Beep ON/OFF	ON
at RX	* (B)	Null	MR-CH Bank/Free	Bank (16CH*2Bank)
only	* (C)	Null		
	* (D)	Null		
	(Up/Dn)	Up/Dn		

Turbo Speedial A, B, C, D:

Immediately calls commonly used telephone or subscriber numbers during SmarTrunk II operation. See page 46 for details

This function is used for the SmarTrunk II™ operation only.

Programming memory Speed Dial

- ① Push and hold the [*] until a high-pitch beep is heard.
 - ② Enter the memory location (0–9, A, B, C, D), the telephone or subscriber number, then [1], [*] (or [3], [*] if for another system subscriber).
 - A high-pitch beep informs successful programming.
 - Memories [A]–[D] are used for the Turbo Speedial.
- Note: This function is available for the IC-F3/F4 only.

• **Mic Function**

Selects remote control capability from an optional HM-75A SPEAKER MICROPHONE.

[▲], [▼], [A] and [B] switches on the HM-75A operate as [▲], [▼], [A] and [B] switches on the transceiver, respectively.

When using with IC-F3S or IC-F4S, [A] and [B] switches on the HM-75A operate with the function assigned in the * (A) and * (B) in this screen, respectively.

at RX	* (A)	Null
	* (B)	Null

• **RF PWR (H/L)**

Selects transmit output power setting condition from MR CH Individual and Override.

Selected transmit output power level with the [High/Low] switch is kept for all channels regardless of the individual power setting programmed in RF PWR in 5-1 MEMORY CH (p. 22) when 'Override' is selected. However, outputs selected transmit output power level temporarily with the [High/Low] switch when 'MR CH Individual' is selected.

Go to RF PWR

• **Backlight**

Selects LCD backlight lighting condition from Auto, Continuous and OFF.

Auto : Lights for 5 sec. when any switch except [PTT] is pushed.

Continuous:

Lights continuously while the transceiver is powered ON.

OFF : Does not light with any operation.

• **Opening Text**

Enter up to a 7-character transceiver opening message.

The usable characters are A–Z (uppercase), 0–9, \$, ', (,), -, /, <, =, >, @, [, \,], _, | and ~.

• **LCD Contrast**

Selects LCD contrast level from 1: Low and 2: Normal.

• **LCD Display**

Selects display conditions from Text and MR CH+TX Code CH.

Text : The text programmed in Text in 5-1 MEMORY CH (p. 22) is displayed.

MR CH+TX Code CH:

Memory and transmit 5-tone code channel numbers are displayed. In this case, memory channel number is briefly displayed when the operating channel is changed.

Go to Text

• **Beep ON/OFF**

Selects key-touch beep output capability. (Not for lock-out timer, TOT, etc.)

• **MR-CH Bank/Free**

Selects memory channel combination from Bank (8CH*4Bank), Bank (16CH*2Bank), Bank (20CH+12CH) and Free.

Bank (8CH*4Bank), Bank (16CH*2Bank) or Bank (20CH+12CH) divides all available 32 channels into 4, 2 channels groups or 20 channels plus 12 channels, respectively.

Free— channels can be used continuously.

5-3 DTMF AUTODIAL

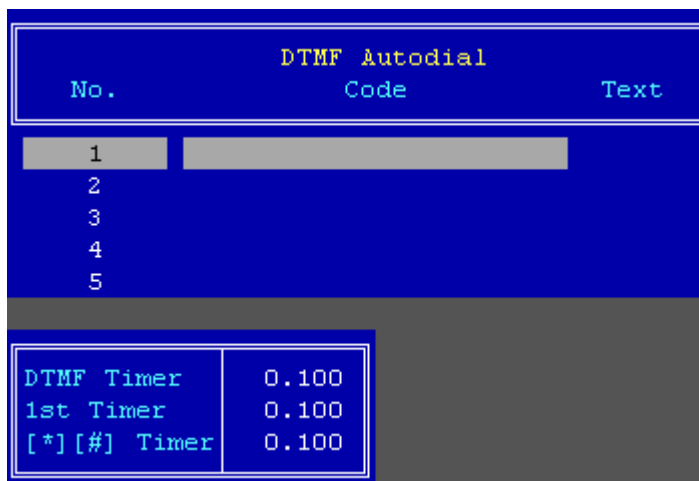

• Code

Enter up to a 24-digit DTMF code for simple and quick dialling.

The usable characters are 0–9, A, B, C, D, E (#) and F (*).

• Text

Enter up to a 7-character text for easy recognition of DTMF usage, etc.

When no text is programmed, the programmed DTMF code number is scrolled.

The usable characters are A–Z (uppercase), 0–9, \$, ', (,), -, /, <, =, >, @, [, \,], _, | and ~.

• DTMF Timer

Enter time period/signal length for each DTMF code emission and interval.

• 1st Timer

Enter time period/signal length for 1st DTMF code emission and interval corresponding to the scanning or power saving of transceiver.

• [*] [#] Timer

Enter time period/signal length for [*] and [#] DTMF code signal emission and interval.

These codes may be used for control codes depending on signaling system.

When these special codes are used for the 1st digit code, the **1st Timer** as above has priority over this setting.

5-4 CONTINUOUS TONE

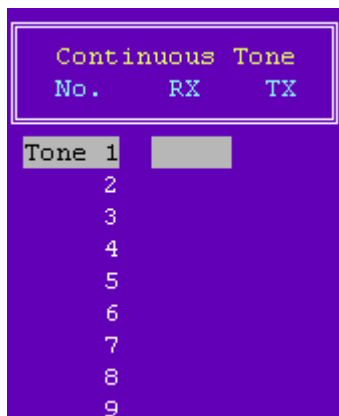

• RX and TX

Enter full CTCSS frequency for each RX and TX as instructed in the **CTCSS/DTCS— RX and TX** in **5-1 MEMORY CH** (p. 21).

Go to CTCSS/DTCS— RX and TX

The programmed continuous tone combinations can be used for temporary or permanent encoder and/or decoder operation.

Temporary operation;

Push [C. Tone CH Ent] switch, then select a continuous tone memory channel via [▲] or [▼] switch.

Permanent operation;

Select a continuous tone memory channel via [▲] or [▼] switch, while pushing and holding [C. Tone CH Ent] switch.

The [C. Tone CH Ent] switch is assigned in **5-2 KEY & DISPLAY ASSIGN** (p. 29).

Go to 5-2 KEY & DISPLAY ASSIGN

5-5 SCAN FUNCTION

Scan Function	
Mode	M1 (Normal)
Text	
PWR Save	ON
Stop Timer	5.000
Resume Timer	3.000
PWR ON Scan	OFF
Auto CH Call	OFF

- **Mode**

Selects scanning mode from the Mode 1, 2, 3 and OFF.

Mode 1 : Normal scan. Scans all 'Tag (Inh)' or 'Tag (Ena)' selected channels. The scan proceeds in sequence from lower to higher channel number.

Mode 2 : Priority scan. The priority channel is monitored every fixed time period during scan (depending on version), or every specified time period programmed in the **Stop Timer** in this screen, as at right, during pause. The busy or paused channel is retained when scan is cancelled.

Mode 3 : Priority scan. Same scanning sequence as Mode 2 above. The priority channel is retained when scan is cancelled.

OFF : Scan function cannot be controlled from the transceiver keypad.

The scanning channels, 'Tag (Inh)' or Tag '(Ena)', are selected in **Scan** in **5-1 MEMORY CH** (p. 23).

The priority channel is selected in **CH Atr** in **5-1 MEMORY CH** (p. 21).

Go to Scan
Go to CH Atr

- **Text**

Enters up to a 7-character text to indicate messages, etc. during scanning.

When no text is programmed, scanning channel text or number is scrolled.

The usable characters are A–Z (uppercase), 0–9, \$, ' , (,) , - , / , < , = , > , @ , [, \ ,] , _ , | , ~.

- **PWR Save**

Selects power save capability during scanning.

Total scanning speed is decreased when the function is turned ON.

- **Stop Timer**

Enters time period for scan pausing on a busy channel (watching interval) when receiving a signal in scan mode 2 or 3 (priority scan), specified in **Mode** as at above left.

- **Resume Timer**

Enters time period for resuming scanning after signal disappears.

- **PWR ON Scan**

Selects automatic scan start capability at power ON from ON and OFF.

Also, automatically restarts scanning even once scanning is cancelled for call transmission or reception, etc., after a specified time has passed when the signal disappears or key operation is finished when ON is selected.

When SmarTrunk ON/OFF is selected in **CH Atr** in this screen (p. 21), "OFF" must be selected.

The scanning restart condition is programmed in **Auto Reset** in **5-1 MEMORY CH** (p. 25), and the time period is programmed in the **Auto Reset— Timer A, Timer B** in **5-7 COMMON** (p. 40).

Go to CH Atr

Go to Auto Reset

Go to Auto Reset— Timer A, Timer B

- **Auto CH Call**

Selects automatic clear channel searching capability when [Call] switch is pushed (call transmission) from ON and OFF.

When [Call] switch is pushed, the transceiver starts scanning, then transmits the previously transmitted 5-tone code after a clear channel is found

The [Call] switch is assigned in **5-2 KEY & DISPLAY ASSIGN** (p. 29).

Go to 5-2 KEY & DISPLAY ASSIGN

5-6 RX CODE CH

CH No.	RX Code	Text or ID-Dec	Bell	Emer Cancel	ABC	Beep	Aud Mode	Stun	Scan
1	11111	CALL1	ON			PiRo	Aud		
2	22222	CALL2	ON			PiRo	Aud		
3	33333	CALL3	ON			PiRo	Aud		
4	44444	CALL4	ON			PiRo	Aud		
5	55555	CALL5	ON			PiRo	Aud		
6	66666	CALL6	ON			PiRo	Aud		
7	77777	CALL7	ON			PiRo	Aud		
8	88888	CALL8	ON			PiRo	Aud		
G	-----	GROUP	Blink		---	PiPi	Aud		

Link A Timer	0.800
Compare Digit	12345_
ID Decode Timer	1.600
Beep Repeat Timer	10.000

• RX Code

Enter up to a 7-digit code for receive 5-tone code.

When entering “+” instead of number(s), the digit(s) are used for the status function, which indicates a number message. Any number is accepted for decoding and is indicated on the display instead of text or decoded ID as programmed in the **Text or ID-Dec** as follows when receiving the call.

• Text or ID-Dec

Enter up to a 7-character text for indication when a matched 5-tone code is received. Or, select ID decode capability to indicate the received ID code on the LCD with the [Space] key.

The usable characters are A–Z (uppercase), 0–9, \$, ', (,), -, /, <, =, >, @, [, \,], _, | and ~.

• Bell

Selects the bell indicator condition when a matched 5-tone code is received from ON, Blink, Null and OFF.

- ON : The bell indicator appears until operation of a key.
- Blink : The bell indicator blinks until operation of a key.
- Null : The bell indicator condition is not change even when a matched 5-tone code is received.
- OFF : The bell indicator goes off.

• Emer Cancel

Selects the Emergency Repeat Call cancelling condition from ON and OFF.

- ON : The Emergency Repeat Call is cancelled when a matched RX code is received.
- OFF : The Emergency Repeat Call cannot be cancelled except when the power is turned power OFF.

Once the Emergency Repeat Call is preformed, the transceiver repeatedly transmits the emergency call at specified intervals until the selected cancelling condition is performed.

• ABC

Selects the answer back call capability from STN, SGL, XX (num) and OFF.

- STN : Transmits the station code which is selected with the channel assigned code.
- SGL : Transmits a 1 kHz single tone for 2 sec.
- XX (num):
Transmits the specified TX code channel number (TX code channel number must be entered), regardless of the operating channel.
- OFF : No answer back operation.

5-6 RX CODE CH— Continued

CH No.	RX Code	Text or ID-Dec	Bell	Emer Cancel	ABC Beep	Aud Mode	Stun	Scan
1	11111	CALL1	ON		PiRo	Aud		
2	22222	CALL2	ON		PiRo	Aud		
3	33333	CALL3	ON		PiRo	Aud		
4	44444	CALL4	ON		PiRo	Aud		
5	55555	CALL5	ON		PiRo	Aud		
6	66666	CALL6	ON		PiRo	Aud		
7	77777	CALL7	ON		PiRo	Aud		
8	88888	CALL8	ON		PiRo	Aud		
G	-----	GROUP	Blink		---	PiPi	Aud	

Link A Timer	0.800
Compare Digit	12345_
ID Decode Timer	1.600
Beep Repeat Timer	10.000

• **Beep**

Select beep output pattern when a matched 5-tone code is received from Pi, PiPi, PiRo, Pi/R, PiPi/R, PiRo/R, Null and OFF.

- Pi : Emits 1 high beep once.
- PiPi : Emits 2 high beeps once.
- PiRo : Emits 1 high and 1 low beep 3 times.
- Pi/R : Emits 1 high beep repeated with the specified intervals.
- PiPi/R : Emits 2 high beeps repeated with the specified intervals.
- PiRo/R : Emits 1 high and 1 low beep 3 times, repeated with the specified intervals.
- Null : Beep emission (or non emission) is retained even when receiving a matched 5-tone.
- OFF : Repeated beep emission is turned OFF.

The repeating interval is programmed in the **Beep Repeat Timer** in this screen (p. 36).

Go to Beep Repeat Timer

• **Aud Mode**

Selects the transceiver’s receiving condition when a matched 5-tone code is received or does nothing (trough) from Aud, In_A and Null.

- Aud : Audible mode is selected.
- In_A : Inaudible mode is selected.
- Null : Retains audible status

• **Stun**

Selects the transceiver’s basic condition when receiving a matched 5-tone code is received from Kill, Stun and OFF.

- Kill : The transceiver cannot be used. Cloning is necessary to activate the transceiver.
- Stun : A message, “SORRY”, appears and transceiver cannot be used. To use the transceiver, turn power OFF and ON again. At this time, password input is necessary.
- OFF : The transceiver can be used continuously.

The password is programmed in **User Password** in **5-9 COMMON** (p. 40)

Go to User Password

• **Scan**

Selects scanning condition when a matched 5-tone code received from Cancel, Start and Null.

- Cancel : Cancels the scan.
- Start : Starts the scan.
- Null : Scan condition is unaffected.

• **Link A Timer**

Enter the non-modulated time period before transmitting an answer back call.

• **Link A Timer Timing diagram**

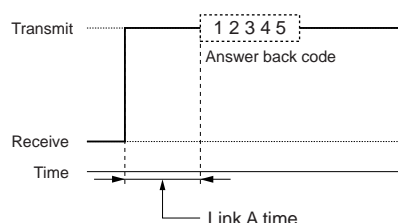

5 SCREEN MENU OPERATION— PMR

5-6 RX CODE CH— Continued

CH No.	RX Code	Text or ID-Dec	Bell	Emer Cancel	ABC Beep	Aud Mode	Stun Scan
1	11111	CALL1	ON		PiRo	Aud	
2	22222	CALL2	ON		PiRo	Aud	
3	33333	CALL3	ON		PiRo	Aud	
4	44444	CALL4	ON		PiRo	Aud	
5	55555	CALL5	ON		PiRo	Aud	
6	66666	CALL6	ON		PiRo	Aud	
7	77777	CALL7	ON		PiRo	Aud	
8	88888	CALL8	ON		PiRo	Aud	
G	-----	GROUP	Blink		--- PiPi	Aud	

Link A Timer	0.800
Compare Digit	12345_
ID Decode Timer	1.600
Beep Repeat Timer	10.000

• Compare Digit

Selects comparative digits for 5-tone decoder. (ignores other digits for the decode actions)

When a “+” (status code) is programmed in the **RX Code** in this screen (p. 34), the digit is not compared even if selected.

Go to RX Code

• ID Decode Timer

Enter time period for decoding an ID code completely when ‘ID-Dec’ is selected in **Text or ID-Dec** in this screen (p. 34).

• ID decode Timer

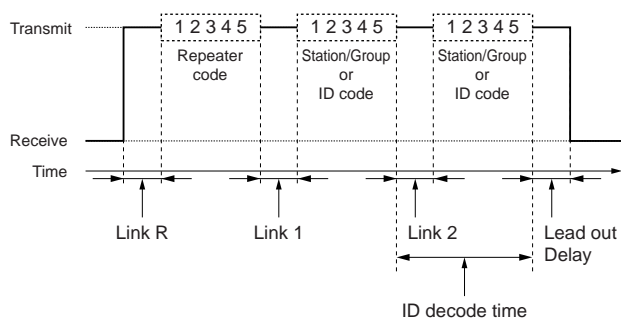

Go to Text or ID-Dec

• Beep Repeat Timer

Enter time period for repeated beep interval for Pi/R, PiPi/R and PiRo/R beeps selected in **Beep** in this screen (p. 35).

Go to Beep

5-7 TX CODE CH

CH No.	TX Code	Input Digit	Up-Date	ABC Dec	Aud Sel
1	11111	45	ON		ON
2	22222	45	ON		ON
3	33333	45	ON		ON
4	44444	45	ON		ON
5	55555	45	ON		ON
6	66666	45	ON		ON
7	77777	45	ON		ON
8	88888	45	ON		ON
9	99999	45	ON		ON
10	00000	45	ON		ON
11	00000	45	ON		ON
12	00000	45	ON		ON
13	00000	45	ON		ON
14	00000	45	ON		ON
15	00000	45	ON		ON
16	00000	45	ON		ON

TX Code Common	
Long Tone Timer	0.700
Link R Timer	0.800
Link 1 Timer	0.800
Link 2 Timer	0.800
Lead out Delay Timer	0.200
ABC Decode Timer	1.600
Displayed Digit	12345__
Special Tone (Group)	A
(Repeat)	E
(Link2)	F
PTT Call at Inaudible	OFF

• TX Code

Enter up to a 7-digit code for transmitting 5-tone station, ID or repeater codes. Up to 24 channels are available.

Usable codes are [0]–[9], [A]–[E] (or [#]) and group code ([G] or [*]).

The programmed TX code in CH No. 24 is normally used for the reset code and its automatically transmitted when In_A+R or Both+R is selected for the mute condition selection after [Moni (Audi)] switch action in **Switch Action— Moni** in *5-1 MEMORY CH* (p. 23).

Go to SW Action— Moni

• Input digit

Select digits for transmit 5-tone code manual entering capability in relation to [TX code] switch assignment.

Only indicated digits can be entered.

[TX code] switch is assigned in the *5-2 KEY & DISPLAY ASSIGN* (p. 30).

Go to 5-2 KEY & DISPLAY ASSIGN

• Up-Date

Selects transmit 5-tone code overwrite capability after manual code entering using [TX Code] switch from ON and OFF.

ON : Original transmit 5-tone codes are overwritten.

OFF : Original transmit 5-tone codes are not changed (changes the code temporarily).

• ABC— Dec

Selects answer back decode/indication capability from ON and OFF.

The decoded answer back code is indicated when the specified TX code is used as the station code.

• ABC— Aud

Selects automatic 5-tone mute release capability from ON and OFF.

When 'ON' is selected, the transceiver releases a 5-tone mute after an answer back code is received when the TX code channel is used.

Both the **SW Action— Call** and **SW Action— PTT** in *5-1 MEMORY CH* (p. 24) should be turned OFF when ON is selected in this setting.

Go to SW Action— Call, PTT

• Sel

Specifies selectable TX code channel from the transceiver's keypad for flexible call operation.

Channels selected as 'ON' can only be selected (accessed) from the transceiver keypad.

• Long Tone Timer

Enters time period for the 1st digit code emission length when long tone function is specified at the **5Tone Signaling— RPT, STN, ID** in *5-1 MEMORY CH* (p. 26).

Go to 5Tone Signaling— RPT, STN, ID

• Link R, Link 1, Link 2, Lead out Delay Timers

Enters the time period for unmodulated signal length before emitting 1st 5-tone code, prior to returning to receive mode, as well as between each code.

• Link R, 1, 2 and Lead out Delay Timer

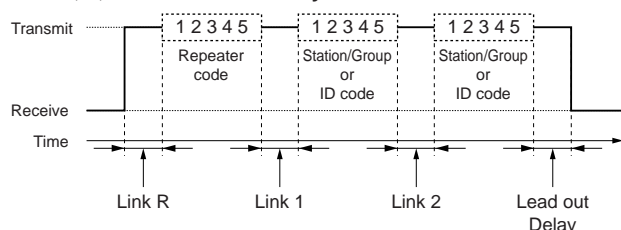

5 SCREEN MENU OPERATION— PMR

5-7 TX CODE CH— Continued

CH No.	TX Code	Input Digit	Up-Date	ABC Dec	Aud Sel	TX Code Common	
1	11111	45	ON		ON	Long Tone Timer	0.700
2	22222	45	ON		ON	Link R Timer	0.800
3	33333	45	ON		ON	Link 1 Timer	0.800
4	44444	45	ON		ON	Link 2 Timer	0.800
5	55555	45	ON		ON	Lead out Delay Timer	0.200
6	66666	45	ON		ON	ABC Decode Timer	1.600
7	77777	45	ON		ON	Displayed Digit	12345__
8	88888	45	ON		ON	Special Tone (Group)	A
9	99999	45	ON		ON	(Repeat)	E
10	00000	45	ON		ON	(Link2)	F
11	00000	45	ON		ON	PTT Call at Inaudible	OFF
12	00000	45	ON		ON		
13	00000	45	ON		ON		
14	00000	45	ON		ON		
15	00000	45	ON		ON		
16	00000	45	ON		ON		

• ABC Decode Timer

Enters the time period for answer back decode. The timer count is shown in the following diagram.

• ABC Decode Timer

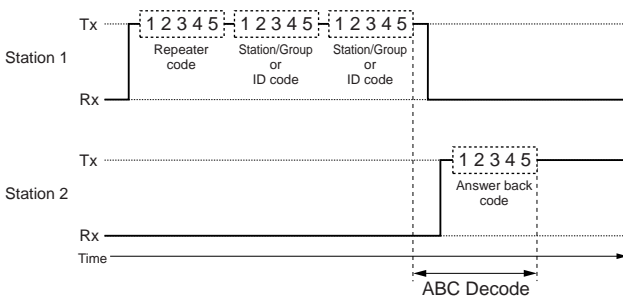

• Displayed Digit

Select viewable 5-tone code digits on the display. The selected viewable digits condition is also applied to transmit (station/group), received ID and answer back code indications programmed in **TX Code** in this screen (p. 37), **Text or ID-Dec** in **5-6 RX CODE CH** (p. 34) and **ABC— Dec** in this screen (p. 37), respectively.

Go to TX Code

Go to Text or ID-Dec

Go to ABC— Dec

• Special Tone (Group), (Repeat), (Link 2)

Select special tone code instead of Group, Repeat code and Link 2 timer.

Group : The decoder accepts this code regardless of the programmed code.

Repeat : Used when the same codes are repeated. (e.g. 11111 -> 1E1E1)

Link 2 : Emits the code instead of no modulation between station and ID codes (for link 2 timer). Usable [F] for no modulation.

Normally, form [A]–[F] code is assigned for each special tone.

• PTT Call at Inaudible

Selects call operation capability with [PTT] switch while 5-tone mute is activated from ON and OFF.

The **Switch Action— PTT** in **5-1 MEMORY CH** (p. 24) must be turned OFF when 'ON' is selected.

Go to Switch Action— PTT

5-8 5TONE FORMAT

5Tone Format		
Format	Tone Period	Notone Timer
CCIR	0.100	0.160
ZVEI1	0.070	0.100
ZVEI2	0.070	0.100
DZVEI	0.070	0.100
EEA	0.040	0.060
EEA2	0.040	0.060
DAPL	0.100	0.160
EIA	0.033	0.060

- **Tone Period**

Enters the time period for each digit tone signal emission length within 0–0.255 sec. in 0.001 sec. steps.

A longer period/emission length programmed in **Long Tone Timer** in *5-7 TX CODE CH* (p. 37) has priority for the 1st digit when long tone is activated.

The long tone is selected in the **5Tone Signaling—RPT, STN, ID** in *5-1 MEMORY CH* (p. 26).

Go to Long Tone Timer

Go to 5Tone Signaling— RPT, STN, ID

- **Notone Timer**

Enters the time period with maximum acceptable tone interval between each code detection.

The following code is received as a different code when the receiving tone interrupts for more than the programmed time period.

Approx 1.5 times the tone period time is recommended.

5 SCREEN MENU OPERATION— PMR

5-9 COMMON

Common 1		Common 2	
User Password	1234	PWR ON Password	OFF
Clone Comment			
Auto Reset Timer A	30.000	Transceiver Data Out	Enabled
Timer B	OFF		
Inactive Timer	60.000	Scrambler Type	Rolling
TOT Timer	30.000	Scrambler Group Code	1
Penalty Timer	20.000	Synchronous Capture	Standard
ID Out	OFF	Tone Start Timing	OFF
Beep	OFF		
Lockout Penalty Timer	5.000		
CTCSS Reverse Burst	0.400		

• User Password

Enters up to a 4-digit user password for the power ON password function or for cancelling the “Stun” condition.

The power ON password function is specified in **PWR ON Password** in this screen (p. 42), and the “Stun” function is specified in **Stun** in **5-6 RX CODE CH** (p. 35).

Go to Power ON Password

Go to Stun

• Clone Comment

Enters up to a 16-character text for quick identification of a transceiver’s content.

The programmed comment of connected transceiver can be checked without reading all other existing programmed data. See page 44, **6-3 INFORMATION**, for details.

The programmed comment of saved programming data can also be checked in the file table.

See page 4, **3 FILE MENU OPERATION**, for details.

Go to 6-3 INFORMATION

Go to 3 FILE MENU OPERATION

• Auto Reset— Timer A, Timer B

Enter time period for returning the mute condition to the initial setting, specified in **CH Mute** in **5-1 MEMORY CH** (p. 21), and restarting the scan from a disappearing signal or when key operation is finished, if the power ON scan function is turned ON.

To turn OFF the Auto Reset function, enter “0 (zero)” to one of these settings. (“OFF” will be indicated)

The programmed settings are selected in **Auto Reset** in **5-1 MEMORY CH** (p. 25).

The power ON scan function is programmed in **PWR ON Scan** in **5-5 scan function** (p. 33).

Go to CH Mute

Go to Auto Reset

Go to PWR ON Scan

• Inactive Timer

Enters the time period for returning the mute condition to the initial setting, specified in **CH Mute** in **5-1 MEMORY CH** (p. 26).

This setting is used with the **Auto Rest Timer A** or **Timer B** as above by selecting ‘TimAI’ or ‘TimBI’ in **Auto Reset** in **5-1 MEMORY CH** (p. 25).

Go to Auto Reset

5-9 COMMON—Continued

Common 1		Common 2	
User Password	1234	PWR ON Password	OFF
Clone Comment		Transceiver Data Out	Enabled
Auto Reset Timer A	30.000	Scrambler Type	Rolling
Timer B	OFF	Scrambler Group Code	1
Inactive Timer	60.000	Synchronous Capture	Standard
TOT Timer	30.000	Tone Start Timing	OFF
Penalty Timer	20.000		
ID Out	OFF		
Beep	OFF		
Lockout Penalty Timer	5.000		
CTCSS Reverse Burst	0.400		

• **TOT— Timer**

Enters continuously transmittable time period (Time-out timer). Maximum time period is specified for 30, 60 or 180 sec., etc. according to country, local regulation.

The time-out timer function can be turned ON or OFF for each operating channel in **TOT** in **5-1 MEMORY CH** (p. 22).

DO NOT set to only a few seconds, as transmitting will be impossible.

Go to TOT

• **TOT— Penalty Timer**

Enters un-transmittable time period as a penalty when continuously transmitted time has exceeded the specified time period programmed in **TOT— Timer** as above.

The TOT penalty time is the transmit inhibit period when the time-out timer is activated.

• **TOT— ID Out**

Selects automatic ID transmission capability from ON and OFF.

The function automatically transmits an ID code when the time-out timer activates and just before transmission is inhibited.

The ID code is programmed in *No. 5* in **5-3 DTMF AUTODIAL** (p. 32).

Go to DTMF AUTODIAL

• **TOT— Beep**

Selects warning beep output capability for TOT function. Emits warning beep 10 sec. before compulsory shut down of the transmission by the time-out timer when this setting is turned ON.

• **Lockout Penalty Timer**

Enters un-transmittable time period as a penalty when transmitted on busy channel. The un-transmittable condition is kept for the programmed time period even if the channel is cleared.

The lockout penalty time is the transmit inhibit period when the user attempts to transmit while in a lockout condition. The transmission is inhibited for the lockout penalty time even when the lockout condition is cleared.

• **CTCSS Reverse Burst**

Enters time period for transmission delay with [PTT] switch operation and CTCSS signal.

The transceiver still transmits for the programmed period without the CTCSS encoder after [PTT] is released. This removes the transceiver's 'Squelch delay'.

• **CTCSS Reverse Burst**

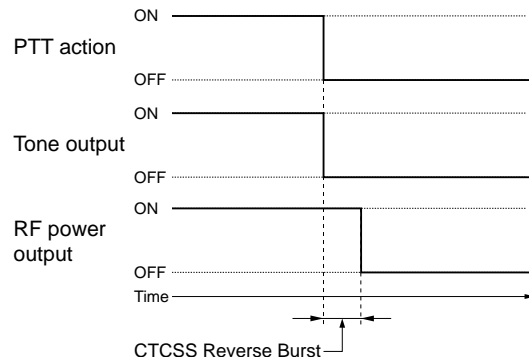

5 SCREEN MENU OPERATION— PMR

5-9 COMMON—Continued

Common 1		Common 2	
User Password	1234	PWR ON Password	OFF
Clone Comment			
Auto Reset Timer A	30.000	Transceiver Data Out	Enabled
Timer B	OFF		
Inactive Timer	60.000	Scrambler Type	Rolling
TOT Timer	30.000	Scrambler Group Code	1
Penalty Timer	20.000	Synchronous Capture	Standard
ID Out	OFF	Tone Start Timing	OFF
Beep	OFF		
Lockout Penalty Timer	5.000		
CTCSS Reverse Burst	0.400		

• PWR ON Password

Selects power ON password function capability from ON and OFF.

When the function is turned ON it is necessary to enter the 4-digit password programmed in the **User Password** in this screen (p. 40). However, the password must be entered after receiving a "Stun" signal regardless of this setting.

The Stun condition is programmed in **Stun** in **5-6 5STONE CODE CH** (p. 35).

Go to User Password

Go to Stun

• Transceiver Data Out

Selects transceiver's programmed data out capability by both using this software and cloning between transceivers from Enable and Disable.

The setting does not inhibit data writing, therefore over writing data is still possible even when 'Disable' is selected.

• Scrambler Type

Selects scrambler type from Rolling and Non-rolling.

Selects Rolling when the optional voice scrambler unit, UT-110 (#01), is installed, selects Non-rolling when UT-109 is installed.

UT-110 and UT-109 are not compatible due to a different scrambling systems. However, UT-110 can be used instead of UT-109 by selecting 'Non-rolling' in this item

The **Scrambler Group Code** as follows must be programmed when UT-110 is used with Rolling setting.

• Scrambler Group Code

Selects scrambler group code from 1, 2, 3 and 4 when the optional voice scrambler unit, UT-110 (#01), is installed and Rolling is selected in the **Scrambler Type** as above.

It is not required to program when the optional voice scrambler unit, UT-109, is installed.

• Synchronous Capture

Selects synchronous capture mode from Standard and Continuous.

It is recommended that 'Standard' is selected for simplex/normal operation, 'Continuous' for repeater operation.

• Tone Start Timing

Selects reference tone signal delay time from OFF, 0.3sec., 0.6 sec. and 1.1 sec.

The setting is used to synchronize voice scrambling timing when the other stations/transceivers are in power save mode.

5-10 EXPERT

Expert	
Fast Scan Timer	0.100
Slow Scan Timer	0.500
TX DTCS Inverse	Normal
RX DTCS Inverse	Normal
Emer SW ON Timer	2.000
SW OFF Timer	1.000
Start/Repeat	10.000
PWR Save Start Timer (1st)	5.000
Timer (2nd)	60.000
Low Beep Frequency	500
High Beep Frequency	1000

- **Fast Scan Timer**

Enters time period for scanning of each channel without CTCSS/DTCS programming.

An appropriate time is set by default and scan may not stop when setting a value less than the default.

- **Slow Scan Timer**

Enters time period for scanning of each channel with CTCSS/DTCS programming.

An appropriate time is set by default and scan may not stop when setting a value less than the default.

- **TX DTCS Inverse**

Selects the transmit DTCS code polarity.

In order for the transceiver to communicate using a DTCS code, the polarity of the transmitting transceiver's transmit code must be the same as the polarity of the receiving transceiver's receive code.

- **RX DTCS Inverse**

Selects the receive DTCS code polarity.

In order for transceivers to communicate using DTCS codes, the polarity of the receiving transceiver's receive code must be the same as the polarity of the transmitting transceiver's transmit code.

- **Emer SW ON Timer**

Enters time period for which [Emergency Repeat] or [Emergency Single] switch must be held to activate the emergency function.

Push and hold [Emergency Repeat] or [Emergency Single] switch for the programmed time period to make an emergency call.

- **Emer SW OFF Timer**

Enters time period for which [Emergency Repeat] or [Emergency Single] switch must be held to cancel the emergency function.

Push and hold [Emergency Repeat] or [Emergency Single] switch for the programmed time period to cancel an emergency call before an emergency signal is transmitted.

However, once an emergency call is transmitted, the call cannot be cancelled regardless of this setting.

- **Emer Start/Repeat**

Enter the time periods for the emergency call delay and interval.

The transceiver makes an emergency call after passing the programmed time period when the emergency function is activated.

The transceiver transmits emergency signal repeatedly at this interval until an "Emergency Cancel" code is received when [Emergency Repeat] is used.

- **PWR Save Start Timer (1st), (2nd)**

Enter the time period for the power saver function start timers within 0–25.5 sec. for the 1st, and 1–255 sec. or OFF (enter 'OFF', when 'OFF' is selected) for the 2nd timer.

The 1st timer must be set smaller than the 2nd timer, due to the 2nd timer/power saver function activates after the fact that the 1st timer/power saver. Otherwise the 1st timer does not activate. The 2nd timer will be set to 'OFF' when the UT-110 voice scrambler unit is installed. The long timer setting will be invalid.

- **Low Beep Frequency, High Beep Frequency**

Enter beep audio frequency for each Low (for error) and High (for regular) beep within 400 to 2998 Hz range, respectively.

The nearest available frequency is selected automatically.

6

CLONE MENU OPERATION

6-1 READ ← TR

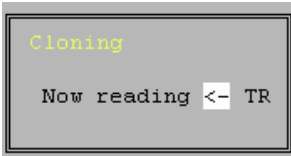

The information screen as at left, is displayed while reading data from the transceiver.

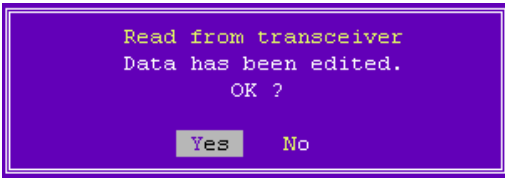

The confirmation screen as at left, appears when previous data is modified. Select “Yes” when the data is not necessary, or “No” when it is necessary to save data. (p. 4: **3-2 SAVE**)

Go to 3-2 SAVE

6-2 WRITE → TR

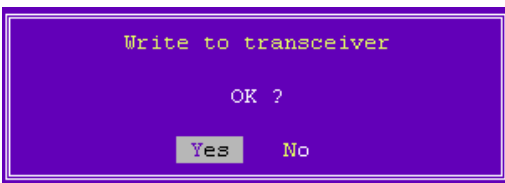

The confirmation screen is displayed as at left, after pushing [Ent], select “Yes” when modified data is to be programmed, or “No” when it is necessary to save the transceiver’s data, etc.

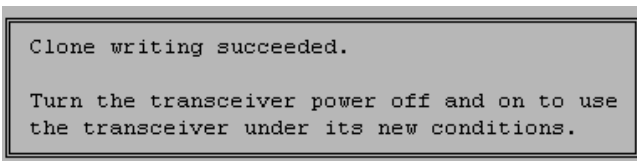

The information screen as at left, appears when cloning has succeeded.

6-3 INFORMATION

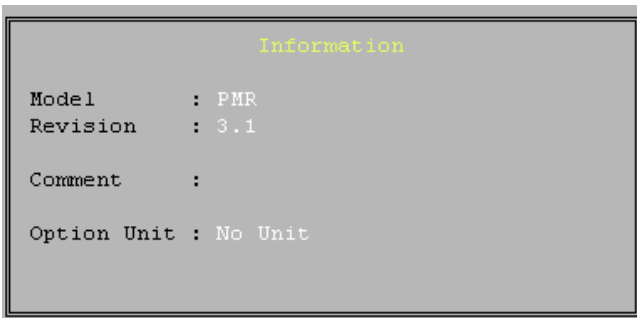

The information screen is displayed as at left.

The screen indicates Model type selected in the **Model menu** (p. 3), CPU’s revision, clone comment and optional unit installation condition.

The clone comment is programmed in the **Clone Comment** in **4-7/5-9 COMMON** (p. 17; LMR/p. 40; PMR).

Go to Model menu

Go to Clone Comment— LMR

Go to Clone Comment— PMR

7-1 DISPLAY TYPE

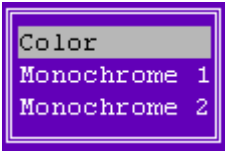

Select the preferred display type from color, monochrome 1 and monochrome 2. Each display sample is as below.

Color

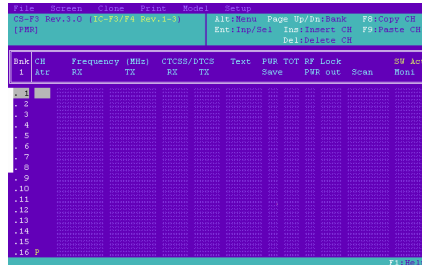

Monochrome 1

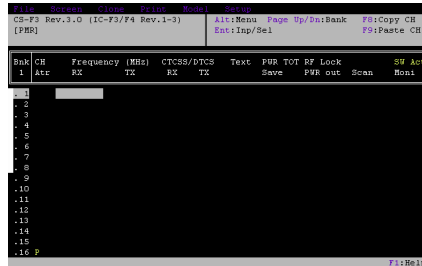

Monochrome 2

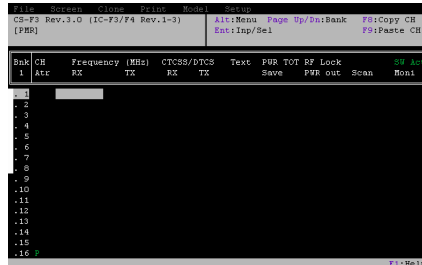

7-3 RS-232C

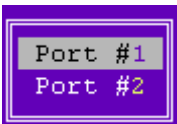

Select the RS-232C serial port that the cloning cable is connected to.

- This programming is necessary when an optional UT-105 SmarTrunk II Logic Board is installed. Programming operation methods are also written in the instruction manual for UT-105.

8-1 STARTING THE PROGRAM

- ① Boot up DOS.
- ② Insert the CS-F3 backup disk into drive A*.
- ③ Type the following to start the program
iccf3.exe [Enter], or ex2095.exe [Enter]
When ex2095.exe is typed to start the program, skip step ④.
- ④ Select "UT-105 (SmarTrunk II)" with the arrow keys ([↑] and [↓]), then push the [Enter] key to start the program.
- ⑤ After the start up screen appears, set or modify the data as desired.
 - By pushing [Alt] or [Esc] key, the TOP menu will be brought up.
 - Use the arrow keys ([↑], [↓], [←] and [→]) to select menu then push [Ent] or push *highlighted character keys* to open the desired menu.
 - The [Space] key or *Digit keys* toggle the setting.
- ⑥ Use the "File" menu to save the data and to exit the program.

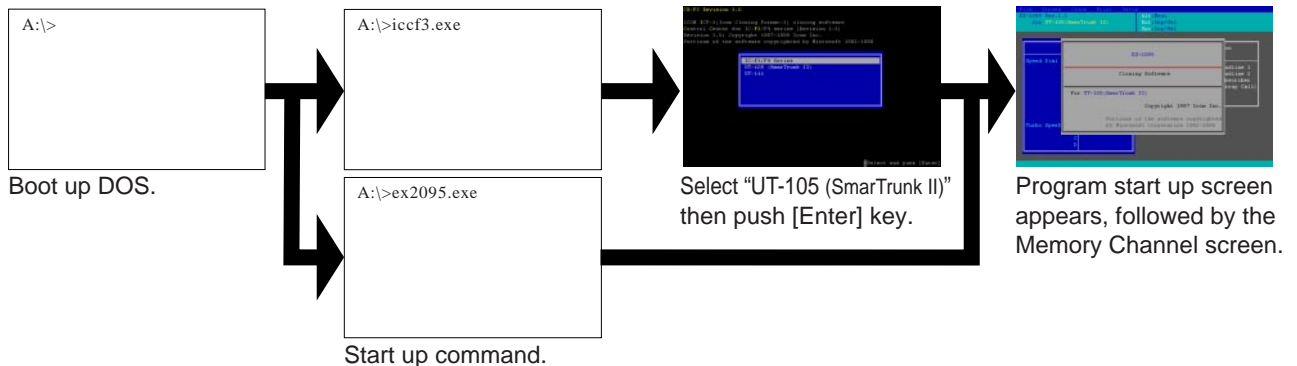

8-2 SCREEN MENU OPERATION— Speed Dial

The screenshot shows a terminal window with a blue background. The title is "Speed Dial". The menu lists "Speed Dial 0" through "9" and "Turbo Speedial A", "B", "C", and "D". To the right, a table defines the routing codes and their destinations.

Routing Code	Destination
1	Subscriber to Landline 1
2	Subscriber to Landline 2
3	Subscriber to Subscriber
4	Fleet-Dispatch(Group Call)
9	Mobile Operator
0	Emergency

• **Speed Dial 0–9**

Enter up to a 16-digit telephone or subscriber number for simple and quick dialling operation.

• **Turbo Speedial A, B, C, D**

Enter up to a 16-digit telephone or subscriber number for simple and quick dialling operation.

The programmed number is immediately recalled and transmitted by pushing the [Turbo Speedial A], [Turbo Speedial B], [Turbo Speedial C] or [Turbo Speedial D] switch assigned in **4-2/5-2 KEY & DISPLAY ASSIGN** screen (p. 11; LMR/p. 31; PMR).

Go to Clone 4-2 KEY & DISPLAY ASSIGN

Go to Clone 5-2 KEY & DISPLAY ASSIGN

8-3 SCREEN MENU OPERATION— Configuration

Configuration		Group Code	
System Tone	3	Group Code 0	0001
Primary Code	0000	1	OFF
Secondary Code	0000	2	OFF
Lower Block Decode	0000	3	OFF
Upper Block Decode	OFF	4	OFF
Priority Subscriber Enable	OFF	5	OFF
Busy Channel Detect	System Tone	6	OFF
Five Digit Access Code	12345	7	OFF
Trunking System ID Number	00	8	OFF
Fleet Dispatch Mode	OFF	9	OFF
Emergency Call Override	OFF	10	OFF
Clear Channel Alerting Mode	OFF	11	OFF
Radio-Kill	Active	12	OFF
Memory Speed-dialing Programming	ON	13	OFF
		14	OFF
		15	OFF

• System Tone

Selects specified system tone code to detect trunking channel condition (busy or clear) from 0–6 given from the system.

The same system tone must be programmed when 'System Tone' is selected in **Busy Channel Detect** as follows.

• Primary Code

Enters a specified 4-digit primary code given from the system.

• Secondary Code

Enters a specified 4-digit secondary code given from the system.

• Lower Block Decode

Enters a specified 4-digit code for lower block decode capability given from the system.

• Upper Block Decode

Enters a specified 4-digit code, or turns off the upper block decode capability given from the system.

The decode code must be in the range of less than +19 from the code programmed in the **Lower Block Decode** as above.

When the code "0000" is programmed in the **Lower Block Decode** as above, "OFF" is automatically programmed in this setting.

• Priority Subscriber Enable

Selects Priority Subscriber Enable capability from ON and OFF.

• Busy Channel Detect

Selects specified busy channel detection method from Carrier and System Tone given from the system.

• Five Digit Access Code

Enters specified five digit access code given from the system.

• Trunking System ID Number

Enters a specified 2-digit trunking system ID number given from the system.

• Fleet Dispatch Mode

Selects specified fleet dispatch mode availability from ON and OFF given from the system.

• Emergency Call Override

Selects emergency call override capability from ON and OFF.

• Clear Channel Alerting Mode

Selects alerting capability when a trunking channel is cleared from ON and OFF.

• Radio-Kill

Selects Radio-Kill function, remotely disabling the transceiver, when a specified code is received from Active and Disable.

• Memory Speed-dialing Programming

Selects Speed Dial and Turbo Speedial memory programming from the transceiver's keypad capability from ON and OFF.

• Group Code 0–15

Enter a 4-digit group code given from the system for simple and quick group call operation.

*All the other programming operation methods are the same as CS-F3.

■ This programming is necessary when an optional UT-111 TRUNKING UNIT is installed. For details of programming operation methods, ask a system operator.

9-1 STARTING THE PROGRAM

- ① Boot up DOS.
- ② Insert the CS-F3 backup disk into drive A*.
- ③ Type the following to start the program
iccf3.exe [Enter], or ex2284.exe [Enter]
When ex2284.exe is typed to start the program, skip the step ④.
- ④ Select "UT-111" with the arrow keys ([↑] and [↓]), then push the [Enter] key to start the program.
- ④ After the start up screen appears, set or modify the data as desired.
 - By pushing [Alt] or [Esc] key, the TOP menu will be brought up.
 - Use the arrow keys ([↑], [↓], [←] and [→]) to select menu then push [Ent] or push *highlighted character keys* to open the desired menu.
 - The [Space] key or *Digit keys* toggle the setting.
- ⑤ Use the "File" menu to save the data and to exit the program.

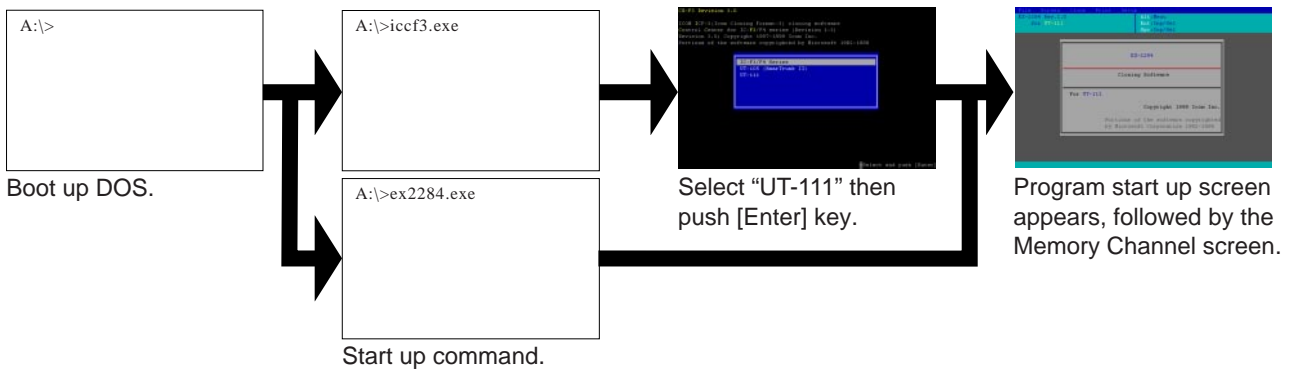

9-2 SCREEN MENU OPERATION— Global

Global	
Five Digit Access Code	12345
Scan Resume Timer(sec)	7.000
Selective Call Timeout(sec)	1.000
DTMF Decoder ID	12345
Decoder Kill ID	
TX Data Polarity	+(Plus)
RX Data Polarity	+(Plus)
TX Data Delay	113

- **Five Digit Access Code**

Enter specified 5-digit access code given from the system.

- **Scan Resume Timer (sec)**

Enter time period for switching decoded group ID during group scan.

When group ID code is decoded, the timer is renewed.

- **Selective Call Timeout (sec)**

Enter stand-by time period between after group ID code is decoded and selective call code to be decoded, during the DTMF selective calling operation.

When group ID code is decoded, the timer is renewed.

- **DTMF— Decoder ID**

Enter an 8-digit ID code for the DTMF decoder.

- **DTMF— Decoder Kill ID**

Enter an 8-digit ID code for the DTMF decoder kill function.

The decoder becomes deactivated when the matched DTMF code is received.

- **TX Data Polarity, RX Data Polarity**

Select specified polarity for each transmit and receive data from + (Plus) and – (Minus) depending on the type of transceiver.

- **TX Data Delay**

Enter specified transmit data delay within 0–255 depending on the type of transceiver.

9-3 SCREEN MENU OPERATION— System 1, System 2

System 1		Group Code	TX ID	RX ID	Scan	Inter-connect	Sel Call	Trans-pond	ANI
Area Number	0	1			Yes	No	No	No	No
Home Repeater	1	2			Yes	No	No	No	No
Priority Receive ID		3			Yes	No	No	No	No
Receive Block Decode Upper ID		4			Yes	No	No	No	No
Receive Block Decode Lower ID		5			Yes	No	No	No	No
		6			Yes	No	No	No	No
		7			Yes	No	No	No	No
		8			Yes	No	No	No	No
		9			Yes	No	No	No	No
		10			Yes	No	No	No	No

System 2		Group Code	TX ID	RX ID	Scan	Inter-connect	Sel Call	Trans-pond	ANI
Area Number	0	1			Yes	No	No	No	No
Home Repeater	1	2			Yes	No	No	No	No
Priority Receive ID		3			Yes	No	No	No	No
Receive Block Decode Upper ID		4			Yes	No	No	No	No
Receive Block Decode Lower ID		5			Yes	No	No	No	No
		6			Yes	No	No	No	No
		7			Yes	No	No	No	No
		8			Yes	No	No	No	No
		9			Yes	No	No	No	No
		10			Yes	No	No	No	No

- **Area Number**
Selects specified area number given from the system from 1 and 0.
- **Home Repeater**
Selects specified home repeater number given from the system within 1–20.
- **Priority Receive ID**
Enters specified priority receive ID given from the system.
- **Receive Block Decode Upper ID, Lower ID**
Enter specified receive block decode ID for each upper and lower given from the system.
- **TX ID, RX ID**
Enter a 3-digit ID code for each transmit and receive.

- **Scan**
Selects automatic scanning capability from Yes and No.
- **Inter-connect**
Selects inter-connect capability from Yes and No.
- **Selective Call**
Selects selective calling capability from Yes and No.
- **Transponds**
Selects answer back capability from Yes and No.
- **ANI**
Selects ANI (Automatic Numbering Identification) transmission capability from Yes and No.

*All the other programming operation methods are the same as CS-F3.

10 DATA CLONING BETWEEN TRANSCEIVERS

■ This operation is useful when cloning transceiver(s) with exactly the same setting, without a PC and programming software.

■ REQUIRED EQUIPMENT

The following hardware is required:

- OPC-474 CLONING CABLE

■ CONNECTION

Connect each item as in following diagram.

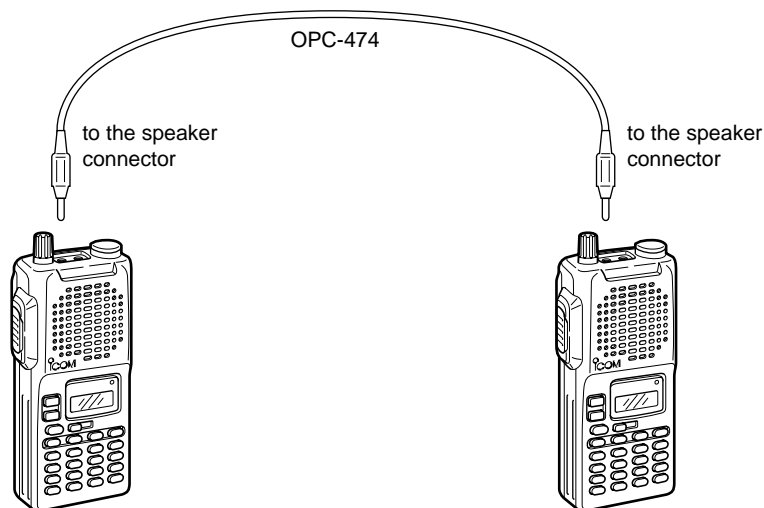

CAUTION: Do not connect an antenna to the transceiver during cloning operation. Received signals may cause cloning errors.

■ STARTING CLONING

- ① First turning power off once on the master transceiver.
- ② Turn the master transceiver power on while pushing and holding [P3] and [▲] switches.
- ③ Push [PTT] switch on the master transceiver to output cloning data to the sub transceiver. (The sub transceiver receives cloning data automatically.)
- ④ Turn power off then on again to enable return to operatable condition.

KEY operation 1

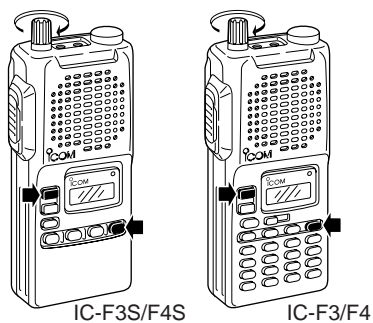

Transceiver indication

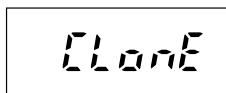

Turn the master transceiver power on while pushing and holding [P3] and [▲] switches to enter into cloning mode.

KEY operation 2

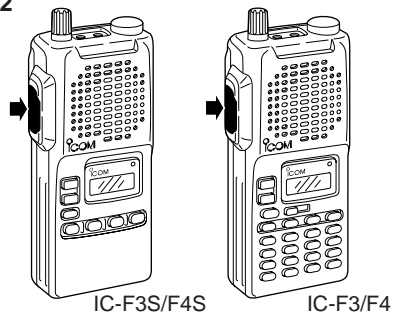

Transceiver indication



Push [PTT] switch to output programmed data to the sub transceiver.

Numbers

1st	
DTMF 1st timer	13, 32
power save start timer 1st	20, 43
2nd	
2nd tone length	15
power save start timer 2nd	20, 43
2-tone	2
2-tone code	15, 16
2-tone dec	7
5-tone	3
5-tone format	26, 39
5-tone signaling— RPT, STN, ID, Pos	26

A

action	
switch action— Call	24
switch action— Moni	23
switch action— PTT	24
switch action— Sel	24
auto	
auto channel call	33
auto reset	7, 21
auto reset timer A, B	17
DTMF autodial	29
ANI	51
answer back	15, 34
ABC aud	37
ABC dec	37
ABC decode timer	38
ANS	15
area number	51

B

backlight	12, 31
bank	
bank up	9
MR-CH bank	12, 31
beep	11, 12, 15, 30, 31, 35
beep frequency	20, 43
bell	15, 34
busy	
busy channel detect	48
busy lock out	6, 22

C

C. tone CH Ent	10, 29
call	29
group call	15
selective call	51
selective call timeout	50
CH Atr (channel attribute)	5, 21
CH mute (channel mute)	26
clear channel alerting mode	48
clone	
clone comment	17, 40
cloning between transceivers	52
code	
2-tone code CH	15
DTMF	13, 32
five digit access code	48, 50
group code	15, 48
primary code	48
secondary code	48

scrambler code	8, 27
scrambler group code	19, 42
RX code	26, 34
TX code	30, 37
continuous tone	13, 32
connection	1
CTCSS	5, 13, 21, 32
channel	13, 32
CTCSS reverse burst	18, 41
frequency	5, 13, 21, 32

D

data	
RX data polarity	50
transceiver data out	18, 42
TX data delay	50
TX data polarity	50
decode	
ABC decode timer	38
DTMF decoder ID	50
DTMF decoder kill ID	50
ID decode timer	36
lower block decode	48
text or ID decode	34
upper block decode	48
delete	4
digit	
compare digit	36
displayed digit	38
five digit access code	48, 50
input digit	37
display type	45
DTCS	13, 32
RX DTCS inverse	20, 43
TX DTCS inverse	20, 43
DTMF	
DTMF autodial	10, 13, 29, 32
DTMF decoder ID	50
DTMF decoder kill ID	50
DTMF re-dial	10, 29
DTMF timer	13, 32
TOT ID out (DTMF)	17, 41

E

emergency	13
emer. cancel	34
emer. start/repeat	20, 43
emer. SW OFF timer	20, 43
emer. SW ON timer	20, 43
emergency call	11, 30
emergency call override	48
emergency channel	5, 21
emergency repeat	11, 30
emergency single	11, 30

F

file	4
fleet dispatch mode	48
frequency	
beep frequency	20, 43
CTCSS frequency	5, 21
operating frequency	5, 21
five digit access code	48, 50

11 INDEX

- G**
- group code 15, 48
 - scrambler group code 19, 42
- H**
- high/low 10, 29
 - high beep frequency 20, 43
 - home repeater 51
- I**
- ID
 - log In/Off 7, 25
 - log/ID 13, 32
 - priority receive ID 51
 - receive block decode lower ID 51
 - receive block decode upper ID 51
 - RX ID 51
 - trunking system ID number 48
 - TX ID 51
 - information 44
 - input digit 37
 - inter-connect 51
- K**
- key assign 9, 28
 - keyboard lock 11, 30
 - kill 15, 35
 - radio-kill 48
- L**
- LCD
 - LCD display 31
 - LCD contrast 12, 31
 - light 9, 28
 - load 4
 - lock 11, 30
 - lock out 6, 22
 - lock out penalty timer 18, 41
 - keyboard lock 11, 30
 - log In/Off 7, 25
 - long tone 26
 - long tone timer 37
 - low beep frequency 20, 43
 - LMR 3
- M**
- memory speed dialling programming 48
 - mic function 11, 31
 - mute
 - channel mute 26
 - monitor 9, 28
- N**
- Null 9, 28
- O**
- opening text 12, 31
 - out
 - TOT ID out 41
- P**
- TOT ID out (DTMF) 17
 - transceiver data out 18, 42
- P**
- password
 - power ON password 18, 42
 - user password 17, 40
 - PMR 3
 - port 45
 - power
 - power save 6, 21
 - power save start timer 20, 43
 - power save scan 14, 33
 - RF power 6, 22, 31
 - primary code 48
 - priority
 - priority CH 9, 28
 - priority channel 5, 21
 - priority scan 14, 33
 - priority receive ID 51
 - priority subscriber enable 48
 - program 1, 46, 49
 - stop timer 33
- R**
- radio-kill 48
 - read 44
 - repeater
 - home repeater 51
 - repeater lock out 6, 22
 - reset
 - auto reset 7, 21
 - auto reset timer A, B 17, 40
 - resume
 - resume timer 14, 33
 - scan resume timer 50
 - re-dial 10, 29
 - RF power 6, 11, 22
 - RS-232C 45
 - RX
 - RX code 26, 34
 - RX data polarity 50
 - RX DTCS inverse 20, 43
- S**
- save 4
 - scan 7, 9, 16, 23, 28, 35, 51
 - power ON scan 14, 33
 - scan mode 14, 33
 - scan resume timer 50
 - scrambler 8, 11, 27, 30
 - scrambler code 8, 27
 - scrambler group code 19, 42
 - scrambler type 19, 42
 - secondary code 48
 - selective call 51
 - selective call timeout 50
 - speed dial 47
 - memory speed dialling programming 48
 - stun 15, 35
 - synchronous capture 19, 42
 - system tone 48

T

- talk around 10, 29
- text
 - 2-tone 15
 - 5-tone 34
 - channel independent 6, 22
 - opening text 12, 31
 - scan 14, 33
 - DTMF 13, 32
- timer
 - DTMF 1st timer 13, 32
 - ABC decode timer 38
 - auto reset timer A, B 17, 40
 - beep repeat timer 15, 36
 - DTMF timer 13, 32
 - emer SW OFF timer 43
 - emer SW ON timer 43
 - fast scan timer 20, 43
 - group timer 15
 - inactive timer 40
 - lead out delay timer 37
 - lock out penalty timer 18, 41
 - long tone timer 37
 - link A timer 35
 - DTMF timer 13, 32
 - ID decode timer 36
 - link R/1/2 timer 37
 - no tone timer 39
 - power save start timer 20, 43
 - resume timer 14, 33
 - scan resume timer 50
 - slow scan timer 20, 43
 - stop timer 14, 33
 - TOT penalty timer 17, 41
 - TOT timer 17, 41
- tone
 - no tone timer 39
 - special tone 38
 - system tone 48
 - tone period 39
 - tone start timing 19, 42
- TOT 6, 17, 21
 - TOT beep 18, 41
 - TOT ID out (DTMF) 17, 41
 - TOT penalty timer 17, 41
 - TOT timer 17, 41
- transponds 51
- trunking
 - LTR trunking 49
 - trunking group SW 11, 30
 - trunking system ID number 48
 - SmarTrunk 5, 21, 46
- turbo Speedial 11, 31, 47
- TX
 - TX code 30, 37
 - TX data
 - TX data delay 50
 - TX data polarity 50
 - TX DTCS inverse 20, 43

U

- up-date 37

W

- write 44

Count on us!

Icom Inc.

6-9-16 Kamihigashi, Hirano-ku, Osaka 547-0002 Japan

S-5452I-1EX-①
© 2000 Icom Inc.