



# STANDARD HORIZON

## MST70

Marine AM/FM Cassette  
Stereo System  
With NOAA Weather

---

### Owner's Manual



Marine Division of Yaesu U.S.A.

# TABLE OF CONTENTS

<b>FEATURES.....</b>	<b>1</b>
<b>REPLACEMENT PARTS.....</b>	<b>2</b>
<b>LISTENING TO FM ON YOUR BOAT.....</b>	<b>2</b>
<b>CASSETTE CARE AND MAINTENANCE.....</b>	<b>2</b>
<b>REMOVING AND FITTING THE FRONT PANEL.....</b>	<b>3</b>
<b>INSTALLATION.....</b>	<b>4</b>
Mounting.....	4
Upright or Overhead Mounting.....	4
Flush Mounting.....	5
Electrical Wiring.....	7
Speaker Connections.....	8
Antenna Connections.....	9
Fuse Replacement.....	9
<b>CONTROLS.....</b>	<b>9</b>
<b>OPERATION.....</b>	<b>10</b>
General Functions.....	10
Radio.....	11
Reset.....	13
Cassette Player.....	14
<b>SPECIFICATIONS.....</b>	<b>15</b>
<b>ACCESSORIES.....</b>	<b>16</b>
<b>LIMITED WARRANTY.....</b>	<b>17</b>

# FEATURES

- **Detachable Face Panel:** Guards against theft by allowing you to remove the face panel, rendering the player unusable. A carry case for the detachable face panel is included.
- **All Electronic Controls:** The Bass, Treble, Volume, Balance and Fader functions are all controlled by touch buttons for greater long term reliability.
- **30 Pre-set Memories:** Store up to 18 FM and 12 AM stations in memory for easy recall.
- **Auto Pre-set Memory System:** Automatically locates and stores local stations into memory for you.
- **Seek and Manual Tuning:** Select stations yourself or let your radio find them for you.
- **Local/DX Switch:** Adjusts your radio's sensitivity for distant or local reception when seeking or scanning.
- **Backlighting:** Special 'night vision' orange back lighting of the display and all controls.
- **Built in Clock:** Automatically displays the time when the unit is switched off, and at the press of a button when using the radio or cassette player.
- **FM Stereo/Mono Switch:** Lets you manually disable stereo operation for improved FM reception in weak signal areas.
- **RCA Outputs:** Provides a separate low level output for connection to external equalizer/booster-amplifier systems.
- **Water Resistant Housing:** Built into a special water resistant marine housing made from corrosion proof materials with a transparent splash-resistant front cover.
- **Hi Output Power:** 25 Watts peak to peak output power per channel.
- **Large easy to read LCD:** Displays station memories, frequency, time and selected functions.
- **NOAA Weather Channels:** Fitted with 10 weather channels for instant access to local weather reports.

## REPLACEMENT PARTS

PART	STANDARD HORIZON PART NUMBER
Dust Cover.....	053002027A
Flush Mount Escutcheon.....	063002002A
Mounting Bracket.....	160004023A
Mounting Bracket Knobs.....	154011017A
Power Wire Harness.....	156007001A
Rear Case Assembly.....	M32649001A
Speaker Wire Harness.....	156008001A

## LISTENING TO FM ON YOUR BOAT

The majority of FM broadcasts are music programs. Compared with AM signals, FM signals have a wider dynamic range, are relatively immune to noise and provide virtually distortion free music reproduction. However, because of the nature of FM signals and the fact that FM stations are usually positioned for shore base reception, receiving them in a moving boat may be accompanied by problems.

- FM programs are broadcast for local reception and cannot be heard at distant locations. To enjoy FM programs at their best, it is important that you tune to a station that is broadcasting locally.
- FM signals can reflect from solid objects such as buildings or hills. If these reflected signals are received along with signals arriving directly from the transmitter, they may mix together to produce what is known as 'multipath distortion'. This distortion is heard as noise. Often moving as little as 3 feet from your position will correct this problem.
- FM signals travel in straight lines. Because the signals are reflected from or absorbed by large solid objects, a signal 'shadow' may be present behind the object which may result in poor reception in that area.

## CASSETTE CARE AND MAINTENANCE

1. Tapes no longer than C-90 (90 minutes playing time) are recommended. Avoid using C-120 tapes because they are extremely thin and may jam your cassette player mechanism.
2. The most common cause of poor sound reproduction is a contaminated tape head. Signs of contamination include low volume on one or both channels and failure to produce high frequency notes. The head can be cleaned using a cotton applicator soaked in alcohol. If the cassette unit is used for more than one hour each day, the head should be cleaned once or twice a month.

3. To extend the life of your cassettes, keep them away from:
  - areas exposed to the sun
  - top of instrument panels
  - the engine
  - areas exposed to heat and moisture
  - magnetic fields (such as speakers)
4. Replace tapes in their plastic cases when not in use.
5. Do not oil revolving parts.

## REMOVAL AND FITTING THE FACE PANEL

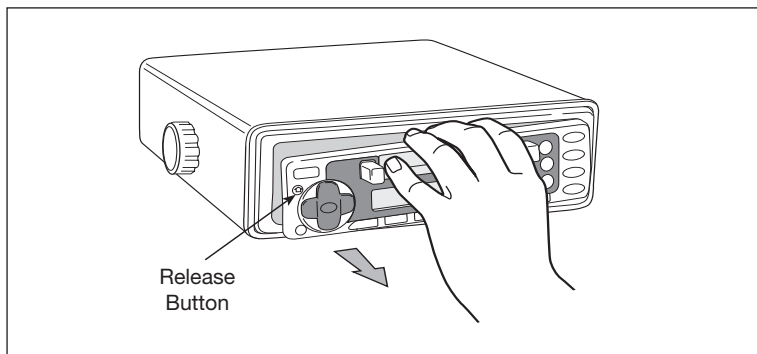

### Removal

Before removing the face panel, turn the unit OFF by pressing the **POWER** button.

1. Press the release button  to release the left-hand end of the face panel.
2. Lift the front panel out towards you.

After removing the face panel, place it inside the supplied case to protect it from damage. Do not leave it in a position where it could be exposed to direct sunlight.

## Refitting

1. Make sure the face panel is the right way up as it cannot be attached upside down.
2. Fit the right-hand end of the face panel into the tabs inside the right-hand end of the unit.
3. Gently press the left-hand end of the face panel into place until it clicks. Only light pressure is required.

## INSTALLATION

### Mounting

The MST70 is designed to be mounted in several different ways so that it can be installed in the most convenient position. **Although the MST70 is water resistant when the front cover is closed, care should be taken to locate it where it will not be subjected to spray or rain.** The diagrams below show the various methods of bracket mounting available.

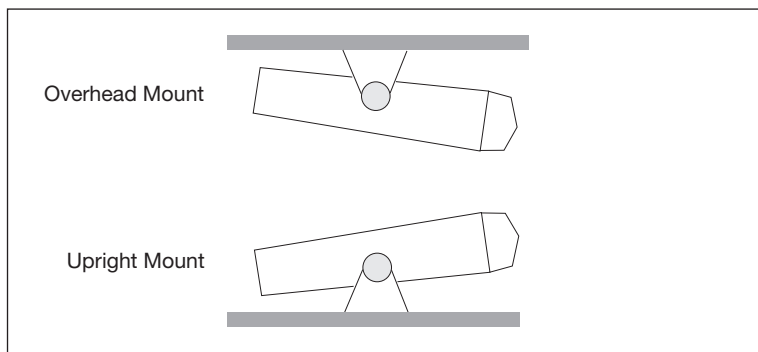

### Upright or Overhead Mounting

1. Attach the two gimbal knobs and self-adhesive rubber washers to the MST70 and slide the unit into the mounting bracket. Ensure the rubber washers are between the bracket and the radio. Tighten the knobs firmly.
2. Temporarily position the MST70 in the desired location, tilting the radio in the bracket to ensure you are able to get the required adjustments for viewing angle etc.
3. Roughly mark the location of the bracket edges, then separate the radio from the bracket and reposition the bracket to mark the mounting hole positions. A range of mounting holes are provided to suit most installations.

4. Screw or bolt the bracket into position. The mounting method will depend on the material to which the bracket is being attached.
5. Slide the MST70 back into the bracket slots and adjust to the required position before tightening the gimbal knobs.
6. Connect the antenna lead and electrical wiring as described later.

## Flush Mounting

The MST70 can be neatly flush mounted into a panel or bulkhead so that just the controls and the protective cover are visible. There are two flush mounting options available. The best option for you will depend on your particular situation.

- If the space behind the bulkhead or panel you have selected has a suitable support shelf and the area is fully accessible, you can use the supplied escutcheon panel as described later.
- If the space behind the bulkhead or panel is largely inaccessible or there is no additional support shelf, we recommend you use the optional CMB60 flush mounting kit (available as an accessory). This kit is more robust, is fully self supporting and allows the MST70 to be installed from the front.

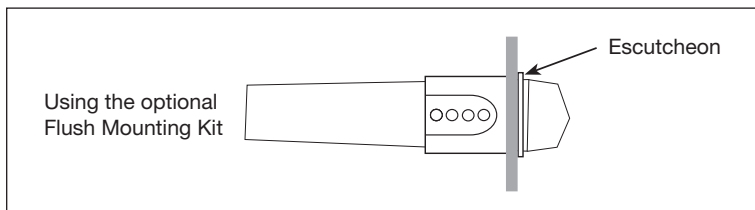

### ***Installation using the supplied Escutcheon Panel.***

1. Select a suitable location on a panel or bulkhead. Examine behind the bulkhead to determine the best method of support for the unit.
2. Place the escutcheon on the panel or bulkhead in the required position and mark around the outside edge of the escutcheon slot wall.

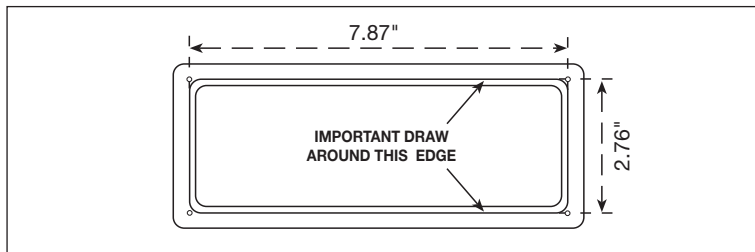

3. Remove the escutcheon and measure the marks. They should measure approximately 7.87" wide and 2.76" high. If not, check the diagram above to ensure that you measured the correct edge.
4. If your measurements are correct, carefully cut the slot around the marked lines, ensuring that you maintain the curves in each corner. Mark and drill the four 0.08" holes in the bulkhead to accept the locating pins at each corner of the escutcheon.
5. Trial fit the escutcheon to ensure it fits securely against the panel. If all is well, place a small dab of glue on each locating pin and press the escutcheon into place. Temporarily hold with tape if necessary.
6. With the escutcheon firmly glued in place, slide the MST70 through the slot from the front and push it all the way in, while leaving a clearance for the front cover to hang in the open position. Open the cover if necessary to ensure the correct clearance.
7. Holding everything in position, mark the location of the internal support bracket(s). Drill the required holes and fit the bracket(s) as required to hold the MST70 firmly in place.

*Note: If using the perforated metal support strip, mount it to the rear of the MST70 as shown in the diagram below.*

8. Complete the antenna lead, speaker and power wiring as described later.

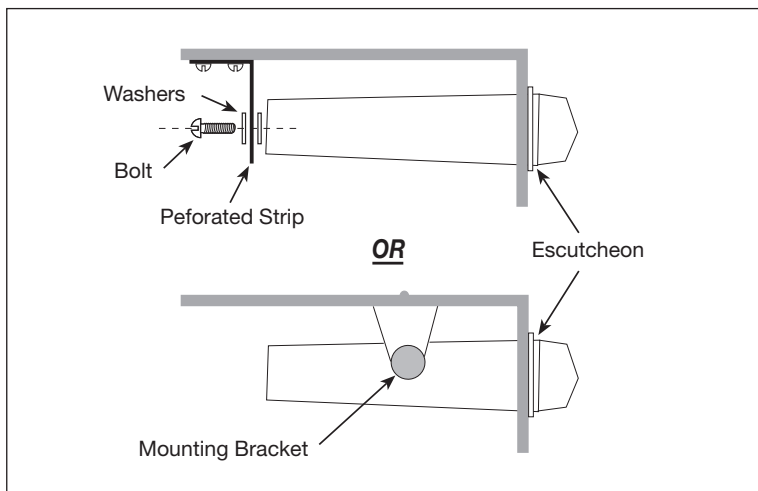

# ELECTRICAL WIRING

## DC Connections

**Caution:** The MST70 is designed for vessels with a 12 Volt negative ground electrical system only!

Referring to the wiring diagram:

1. Connect the Red wire directly to the positive terminal of the vessel's battery, or to a point which has +12 Volts available at all times. This lead maintains the memories within the MST70 and is the main power source for the unit.
2. Connect the Orange wire to the vessel's +12V supply via an appropriate isolating switch or circuit breaker. This lead turns the radio ON and OFF. Alternatively, this wire can be connected directly to the battery's positive terminal and the MST70 switched ON and OFF using it's own controls.
3. Connect the Black lead labelled '**GROUND**' to the battery's negative terminal or to the common negative bus in the electrical system.

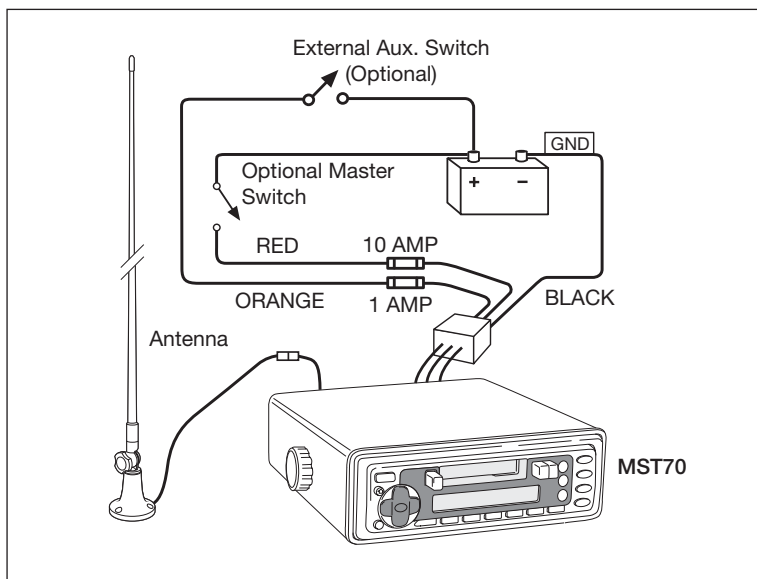

**Important:** Your MST70 is able to maintain it's memories when it is switched off by drawing power directly from your battery via the Red lead. Although the memory backup current is very small (about 7 mA) it may eventually discharge your battery if left connected indefinitely. The time taken to completely discharge

your battery could vary depending on it's Amp-hour rating and condition.

If you do not run your boat's motor regularly or your battery is not kept charged between outings (e.g. Solar or wind charger), we recommend you disconnect the Red lead each time you secure your boat. This is easily done by connecting the Red lead via a Master switch which can be switched off after each outing.

## Speaker Connections

When connecting the speakers, observe the correct polarity as shown in the diagram. Incorrect polarity will result in a reduction of Bass response and stereo effect. The use of speakers with an impedance of less than 4 Ohms is not recommended, as they will cause excessive loading of the MST70's output circuit.

**Caution:** *The MST70 is a four speaker system that requires 2 separate wires for each speaker.*

- **DO NOT** connect the negative (-ve) terminals of the speaker wires together or ground them to any part of the negative electrical Bus.
- **DO NOT** short the +ve and -ve speaker wires together.

*Damage caused by the above will not be covered under warranty.*

Connect all four speakers as shown in the diagram. Adjust the Fader control for the required front/rear balance. If you wish to connect only two speakers,

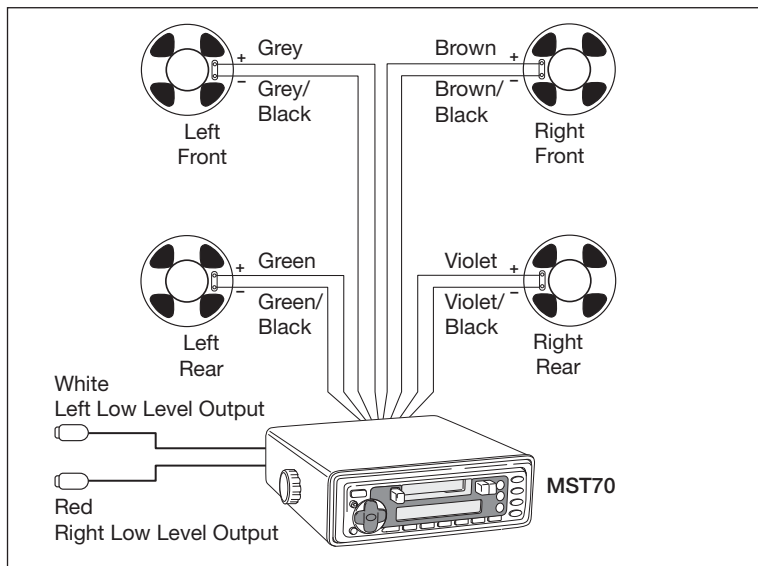

connect these to the Rear speaker wires. The remaining speaker wires should be insulated to ensure they cannot short circuit together or to ground. If using only two speakers, adjust the Fader control to the Rear speakers.

## Antenna Connections

Connect an AM/FM marine antenna to the antenna socket, which extends from the rear of the MST70.

## FUSE REPLACEMENT

If any of the fuses blow, replace them with the following:

Red lead: 10 Amp, 3AG.

Orange lead: 1 Amp, 3AG.

## CONTROLS

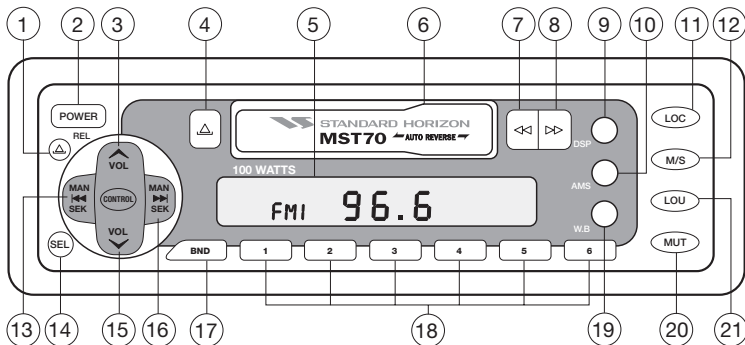

- |                   |                   |                     |                      |
|-------------------|-------------------|---------------------|----------------------|
| 1. Panel Release  | 7. Rewind         | 12. Mono/Stereo     | 18. Station Memories |
| 2. Power          | 8. Fast Forward   | 13. Tune Downwards  | 19. Weather Channels |
| 3. Volume Up      | 9. Display Clock  | 14. Function Select | 20. Mute             |
| 4. Eject Cassette | 10. AMS-Auto      | 15. Volume Down     | 21. Loudness         |
| 5. Display        | Memory Store      | 16. Tune Upwards    |                      |
| 6. Cassette Door  | 11. Local/Distant | 17. Band Selector   |                      |

## GENERAL FUNCTIONS











### Power ON/OFF



To turn the unit ON, press the **POWER** button. The unit will resume the mode that was selected when it was last turned off.

To turn the unit off, press the **POWER** button again. Note that when the unit is turned OFF, the clock is displayed.

### Controls

The Volume, Bass, Treble, Balance and Fader controls are selected electronically. The default selection is the Volume control. To select another control, press the **SEL** button repeatedly until the name of the control you require is displayed on the LCD. Each press cycles to the next control in sequence and the display shows the current setting for that control. If no button is pressed for 3 seconds, the display returns to normal and the control defaults back to the Volume control.



- **Volume:** To adjust the Volume, simply press the **VOL**  or **VOL**  buttons. 'VOL' will appear on the display along with a number indicating the current setting. Press **VOL**  to increase the volume level or **VOL**  to decrease the volume level. A level of 63 on the display indicates maximum volume.
- **Bass:** Press the **SEL** button repeatedly until 'BAS' is displayed. Press **VOL**  to increase the Bass level or **VOL**  to decrease the Bass level. A level of 0 on the display indicates a flat Bass response.
- **Treble:** Press the **SEL** button repeatedly until 'TRE' is displayed. Press **VOL**  to increase the Treble or **VOL**  to decrease the Treble. A level of 0 on the display indicates a flat Treble response.
- **Balance:** Press the **SEL** button repeatedly until 'BL' is displayed. Press **VOL**  to increase the volume in the right speakers. 'BL R' is displayed along with a number representing the volume level of that channel. Press **VOL**  to increase the volume in the left speakers ('BL L' is displayed).

To set the Balance to the center position, press **VOL**  or **VOL**  to reduce the front or rear setting until 'BL C0' is displayed, indicating the centre position.

- **Fader:** Press the **SEL** button repeatedly until 'FA' is displayed.

Press **VOL**  to fade the sound toward the Front speakers (and reduce the volume in the Rear speakers). 'FA F' is displayed along with a number to show the level of the Rear speaker setting.

Press **VOL**  to fade the sound to the Rear speakers (and reduce the volume in the front speakers). 'FA R' is displayed along with a number to show the level of the Rear speaker setting.

To set the fader to the centre position, press **VOL**  or **VOL**  to reduce

the front or rear setting until 'FA C0' is displayed, indicating the centre position.



## Liquid Crystal Display (LCD)

The LCD indicates the station frequency and the selected band along with any other selected functions. The display is permanently back lit for low light viewing.

### Loudness LOU

Press the **LOU** button to increase the bass level at low volume settings. This feature compensates for the ear's inability to pick up low frequency sounds when the volume is turned down. When the **LOU** button is pressed, 'LOUD' appears on the display.

### Mute MUT

Press the **MUT** button to temporarily silence the sound in the speakers. 'MUTE' flashes on the display. You can use this feature when talking on your marine radio. Press **MUT** again (or the **VOL**  or **VOL**  buttons) to restore the sound.

## RADIO

### Band BND

The MST70 has 5 selectable frequency bands labelled FM1, FM2, FM3, MW1 and MW2. Bands FM1 - FM3 are identical and cover the FM band from 87.5 MHz to 107.9 MHz. The MW bands cover the AM frequencies from 530 kHz to 1710 kHz.

Up to 6 channels in each band can be stored in memory, making 18 FM and 12 AM channels available.

The 3 FM and 2 AM bands allow stations from different areas to be stored and kept separate. e.g. Hometown FM stations can be stored using FM1. When traveling to new areas, new local stations can be located and stored using FM2 or FM3, leaving the hometown stations in FM1 for when you return home.

To change bands, press **BND**. Each press will advance to the next band i.e. FM1 - FM2 - FM3 - AM1 - AM2 - etc.

### Tuning

#### Manual Seek (◀▶)

To manually change the frequency in steps, press the **TUN** ◀ or ▶ button repeatedly.

#### Automatic Seek

To automatically tune the radio to a station, press and hold the **TUN** ◀ or ▶ buttons for more than 1 second. The radio will automatically seek through the selected band until a station is found, tuning then stops on that station. To tune

to the next station, press and hold the **TUN** ◀◀ or ▶▶ buttons again.

## Manual Station Preset

To manually store stations in the station memories:

1. Select the required station frequency using the **TUN** ◀◀ or ▶▶ buttons.
2. When the station is tuned, press and hold the required station preset number 1 - 6 for more than 2 seconds. The selected station will be stored in that preset memory and the preset number will be displayed.

To recall station memories, briefly press the required station preset number 1 - 6.

## Auto Memory Store AMS

Use the Auto Memory Store **AMS** function to automatically locate stations and store them in memory. In FM mode, stations are stored in order of signal strength with the strongest signals being stored first. In AM mode, stations are stored in the sequence in which they are found.

To automatically store stations in memory, press and hold the **AMS** button for more than 1 second. 'ATP' will be displayed when Auto Memory Store is functioning.

- In FM mode, the radio will begin tuning upwards through the entire selected band (FM1, FM2 or FM3), starting at the currently selected frequency and returning to that frequency when finished. The memories for that band will then contain the six strongest FM stations in your area.
- In the AM mode the radio will begin tuning upwards (from the currently selected frequency) and will store the first six stations found. Tuning will then stop.

**Note:** If the AM stations you wish to store were not included because the memories were filled up by other unwanted stations, select a frequency to start from that which is just below the stations you wish to store (using the **TUN** ◀◀ or ▶▶ buttons, then press the **AMS** button. Stations will be then located and stored starting from the selected frequency. Alternatively, if the memories were filled by weak unwanted stations, select the Local mode (by pressing the LOC button) so that only the stronger local stations are located and stored - see Local/Distant operation described below.

## Mono/Stereo M/S

The **M/S** button can be used to select either Mono or Stereo reception when in FM mode.

- **Mono:** Selecting Mono improves reception when FM signals are weak or noisy, by disabling stereo detection. When selected, there is no indication on the display. Note: MONO selection is only available on the FM, FM2 or FM3 bands.
- **Stereo:** Select stereo for normal stereo listening on the FM radio bands. When stereo is selected and a stereo signal is being received, **ST** is displayed.

## Local/Distant LOC

Press the **LOC** button to reduce the radio's sensitivity to weaker, distant signals. 'LOC' is displayed. This is particularly useful when seeking or auto-storing local stations as it reduces the weaker signals so that only the stronger local signals are found and stored.

To intentionally receive weak or distant signals, press the **LOC** button again to return to Distant mode.

## Clock DSP

To display the clock on the LCD, press the **DSP** (display) button. To return to the previous mode, press the **DSP** button again.

To set the clock:

1. Press the **DSP** button to display the clock.
2. Now press and hold the **DPS** button while pressing the **◀** button to adjust the hours or the **▶** button to adjust the minutes.

## RESET

Your MST70's functions are controlled by a microprocessor. If after installation, you find that some of the functions do not appear to work correctly, you can reset the microprocessor to restore the radio to its default settings. Note that after the reset, you will need to reprogram your station memories.

The reset button is located beneath the removable front panel. To reset the radio:

1. Press the release button to remove the front panel (see 'Detachable Front Panel' on page 3).
2. Locate the reset switch using the diagram below.
3. Press the switch using a ball point pen or similar.

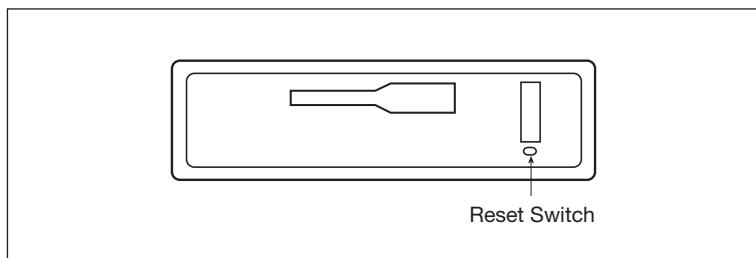

## CASSETTE PLAYER

Insert a cassette tape into the cassette door with the side you wish to play facing upwards and the exposed tape facing to the right. TAPE will appear on the LCD display along with an arrow indicating the direction the cassette is playing.

To fastforward or rewind the cassette, press the fastforward >> or rewind << buttons. Press >> for fastforward and << for rewind regardless of which direction the tape is playing. To stop fastforward or rewind, press the opposite button. i.e. press << to cancel >> etc.

When the tape reaches the end, the unit will automatically reverse the play direction and play the other side of the tape.

To change the play direction manually, press << and >> simultaneously. The direction indicator on the display will change to indicate the new direction.

To stop the tape and eject the cassette, press the eject button ^.

# SPECIFICATIONS

## General

DC Supply Input.....	11 - 16V
Current:	
Standby .....	7 mA
Typical .....	700 mA
Maximum .....	2.5 A
Antenna Input Static & RF Protection.....	Back to Back Diodes
Dimensions (approx).....	7.7(W) x 3.15(H) x 9.3(D) inches
Maximum Height with Bracket.....	4.7 inches

## FM Radio

Frequency Range.....	87.5 - 107.9 MHz
Intermediate Frequency.....	10.7 MHz
Sensitivity (30 dB S/N).....	18 dB $\mu$ V
Selectivity ( $\pm$ 200 kHz).....	-30 dB
Station Memories.....	18, FM1/FM2/FM3

## AM Radio

Frequency Range.....	530 - 1710 kHz
Intermediate Frequency.....	450 kHz
Sensitivity (30 dB S/N).....	20 dB $\mu$ V
Selectivity ( $\pm$ 9 kHz).....	30 dB
Station Memories.....	12 MW1, MW2

## Audio Amplifier

Audio Output (10% Dist.).....	60 Watts Total, 15 Watts RMS x 4CH
Output Impedance.....	4 ohms/channel
Bass Control.....	$\pm$ 8 dB @ 100 Hz
Treble Control.....	$\pm$ 8 dB @ 10 kHz

## Stereo Cassette Deck

Deck type.....	4 track, 2 program
Cross Talk.....	40 dB
Wow & Flutter.....	0.35%

## NOAA Weather Channels

Sensitivity (12 dB SINAD).....	0.7 $\mu$ V
Frequency Range .....	CH:1 162.550 MHz
	CH:2 162.400 MHz
	CH:3 162.475 MHz
	CH:4 162.425 MHz
	CH:5 162.450 MHz
	CH:6 162.500 MHz
	CH:7 162.525 MHz
	CH:8 161.650 MHz
	CH:9 161.775 MHz
	CH:10 163.275 MHz

# ACCESSORIES

- AS101.....6-inch Flush-Mount Speakers  
(available in black or white)
- AS201.....7-inch Flush-Mount Speakers  
(white only)
- CMB60..... Flush-Mount Kit  
(white only)

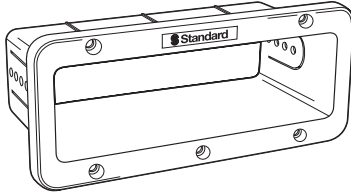

CMB60

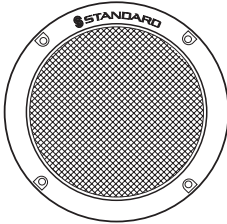

AS101

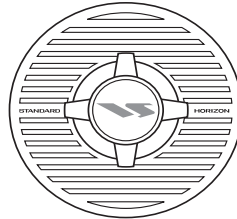

AS201

STANDARD HORIZON MARINE DIVISION OF YAESU U.S.A. warrants to the original purchaser only that each new Marine Product manufactured and/or supplied by STANDARD HORIZON will be free from defects in materials and workmanship under conditions of normal use and service for a period of one (1) year from the date of delivery to the Purchaser. STANDARD HORIZON's liability under this warranty shall be limited to the repair or replacement of the defective product, at STANDARD HORIZON's option, under no circumstances shall STANDARD HORIZON be made liable for consequential, incidental, or other damages arising out of or in any way connected with a failure of the product to perform as set forth herein.

In the event of a defect, malfunction, or failure of the product to conform to specifications during the one-year warranty period, STANDARD HORIZON will repair or replace, at its option and without charge to the Purchaser, the product which upon examination by STANDARD HORIZON shall appear to be defective or not up to factory specifications. To obtain warranty service, the defective product must be returned to STANDARD HORIZON together with proof of the date of purchase. The Purchaser must pay any transportation expenses in returning the product to STANDARD HORIZON. STANDARD HORIZON will examine the product and respond to the Purchaser within approximately four (4) weeks from the date of receipt of the product claimed to be defective.

This limited warranty does not extend to any Product which has been subjected to misuse, neglect, accident, improper installation, or subject to use in violation of the maintenance of operating instructions, if any, furnished by STANDARD HORIZON, nor does this warranty extend to products on which the serial number has been removed, defaced, or changed. STANDARD HORIZON reserves the right to make changes or improvements to its products without notice during subsequent production without incurring the obligation to install such changes or improvements on previously manufactured or sold products.

To receive warranty service, the Purchaser must deliver the product, transportation and insurance prepaid, to **STANDARD HORIZON Marine Division of Yaesu U.S.A., 115 North Wright Brothers Dr. Salt Lake City, Utah 84116-2838**. Include proof of purchase indicating model, serial number and date of purchase. STANDARD HORIZON will return the Product to the Purchaser freight prepaid.

Some states do not allow limitations on the duration of the warranty or exclusions or limitations of incidental or consequential damages so these limitations or exclusions may not apply to you. This warranty gives you specific legal rights, which may vary from state to state.

Lifetime Flat Rate Service Program: For the original Purchaser only, for the lifetime of the unit, STANDARD HORIZON will repair the unit to original specifications.

Note: The flat rate amount is payable by the Purchaser only if STANDARD HORIZON determines that a repair is needed. After the repair, a 90-day warranty will be in effect from the date of return of the unit to the Purchaser.

#### Owner's Records

Model	Serial number
Purchase date	Dealer



**STANDARD HORIZON**

Marine Division of Yaesu U.S.A.

17210 EDWARDS ROAD,  
CERRITOS, CA 90703  
Telephone 562/404-2700

STANDARD HORIZON 1999  
ALL RIGHTS RESERVED  
PRINTED IN CHINA  
January 2000